

SEKONIC Spectrometer

C-800

C-800-U

Operating Manual

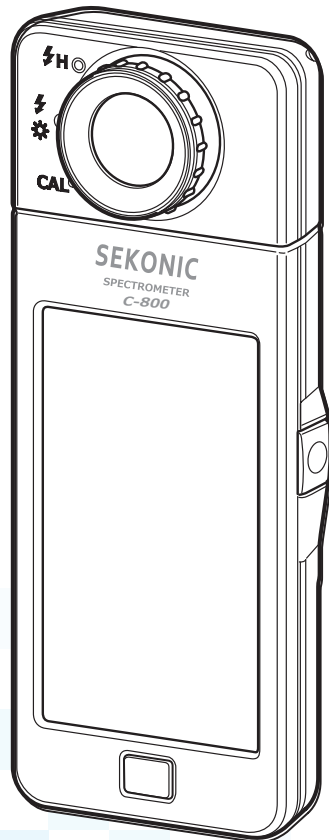

Please read the operating manual carefully to fully understand the features of this product before use and keep it for future use. Keep the operating manual in a safe place. Please see the Startup Guide for information about the basic operations.

Congratulations on your purchase of a Sekonic SPECTROMETER C-800 Series. Please read this operating manual to utilize the many features of the SPECTROMETER C-800 Series.

The SPECTROMETER C-800 Series is a high-performance color meter with a CMOS linear image sensor. The SPECTROMETER C-800 Series makes it possible to precisely measure LED, HMI, Fluorescent lamp, natural light and flash light with color matching function (human eye's characteristic).

The C-800 benefits photographers and cinematographers by enabling the evaluation of light through various color rendering properties, spectral graphs as well as color temperature and filter compensation functions.

The application software of "C-800 Utility" can be used to save the measurement and graphic display, change the meter setting and update the firmware while meter is connected to computer or tablet by USB cable.

* Download the Utility from www.sekonic.com, and install it on your computer.

URL: <https://www.sekonic.com/support/downloads>

To use this Utility, connect your computer to the C-800 Series using a USB cable (Mini-B type, available commercially).





C-800 Series	
C-800	International version except US
C-800-U	US version

■ Terminology and Trademarks

- Windows is a registered trademark of Microsoft Corporation in the United States and/or other countries.
- The official name of Windows is "Microsoft® Windows® Operating System".
- Macintosh and Mac OS are registered trademarks of Apple Computer, Inc. in the United States and/or other countries.
- Rosco, Cinegel and E-Colour+ are the registered trademarks of Rosco Laboratories Inc.
- **LEE** is a registered trade mark of Lee Filters, a division of Panavision Europe Ltd.
- Kodak and Wratten are trademarks of Eastman Kodak Company.
- Fujifilm is a registered trademark of Fujifilm Corporation.
- X-Rite and ColorChecker are trademarks or registered trademarks of X-Rite, Incorporated in the United States and/or other countries. All rights reserved.
- All other company or product names are trademarks or registered trademarks of the respective companies.

■ Safety Precautions

Before using this product, please read this "Safety Precautions" for proper operation.

 WARNING	The WARNING symbol indicates the possibility of death or serious injury if the product is not used properly.
 CAUTION	The CAUTION symbol indicates the possibility of minor to moderate personal injury or product damage if the product is not used properly.
 NOTICE	The NOTICE symbol indicates cautions or restrictions when using the product. Please read all notes to avoid errors in operation.
 NOTE	The reference symbol indicates additional information about the controls or related functions. Reading these is recommended.
	The arrow indicates reference pages.

WARNING

- **Infants or toddlers may accidentally wrap the strap around their neck, so please place it in a location out of their reach. There is a danger of suffocation.**
- **Do not place batteries in open flames, attempt to short, disassemble or apply heat to them, use unspecified batteries, or recharge them (except rechargeable batteries). They may burst and cause fires, serious injury, or damage to the environment.**



CAUTION

- Do not handle this product with wet hands, or leave it in the rain or in a location where it may be splashed with water, submerged, or come into contact with moisture. There is a danger of electric shock if the "Flash Light Cord (PC) Mode" is used.
This may also result in damage to the product.
- Do not attempt to disassemble the product for modification or parts replacement. It may affect measurement results or damage the meter.
- Any significant impact to the meter housing or LCD screen can cause physical damage and failure of performance.
Even when the meter is in the bag or pocket, damage is possible under severe impact or pressure conditions.
- Gently tap the meter's LED panel when changing modes or making selections. Using pointed pens or pencils may scratch the LCD screen or damage the product.
- Infants or toddlers may accidentally grab the strap and swing the product, so please place it in a location out of their reach, as the meter may be damaged by impacts.
- Be careful that the neck strap does not come loose when carrying the product, as the meter may be damaged when dropped.
- This neck strap is made of polyester fiber.
Please refrain from using the product if synthetic fibers cause your skin to become irritated, inflamed or itchy in order to prevent worsening your symptoms.

■ CA Prop 65



WARNING

This product can expose you to chemicals including lead, which is known to the State of California to cause cancer, and Di (2-ethylhexyl) phthalate (DEHP), which is known to the State of California to cause birth defects or other reproductive harm.

For more information, go to www.P65Warnings.ca.gov.

 **NOTICE**

- A protective sheet is attached to the LCD. Peel it off before use.
- Although the LCD monitor is manufactured to very high standards, it is possible to observe a few dead pixels on the screen. This is normal and not a malfunction of the meter.
- Use at altitudes below 2,000m (6,561 feet).
- Our company shall not be liable for any data loss caused by, but not limited to, malicious acts and control errors.
- Be sure not to drop the meter or subject it to sudden impacts, as the meter will be damaged.
- Do not store the meter in areas of high temperature or high humidity, as the meter will be damaged.
- Be careful not to transport the meter from cold to warm moist conditions as condensation will form on the meter and may damage it.
- If the meter is operated in temperatures below -10°C , the response of the LCD will greatly slow down and the display may be difficult to view and read. This will not harm the meter. Also, if the temperature exceeds 50°C , the liquid crystal display will darken and become difficult to read, but when it returns to room temperature it will return to its normal condition.
- If the meter is left in direct sunlight, a vehicle, or near a heater, the unit's temperature will rise and may result in damage. Please be careful when using the meter in these types of locations.
- If the meter is left where corrosive gases may be generated, the gases may affect the product and may result in damage. Please be careful when using the meter in these types of locations.
- In case of disposing the meter, follow the rules of disposal in your area.

Maintenance Notes

- Be careful not to let the Light Receptor become dusty, dirty, or scratched as this may affect the precision of the measurement.
 - If the meter becomes dirty, wipe it with a dry, soft cloth. Never use organic solvents such as thinner or benzine.
-

 **NOTE**

- For used batteries, dispose of them according to the rules of your area.
 - Insulate plus and minus terminals with tape or other insulation material.
 - Do not disassemble the batteries.
-

■ Intended Usage

The meter is designed for:

- Measuring natural or artificial lights to display the various readings for photography and motion picture.
- Displaying the correction values of filters for camera or lighting to match to the target color temperature.
- Managing the aged deterioration of light sources.
- Managing the light source for viewing printed color proofs.
- Checking the color rendering properties of a light source.

Main features of the C-800

Usage	Features
Lighting control for still and motion capture	<ul style="list-style-type: none"> • Measure all lights (LED, HMI, Tungsten, Fluorescent lamp, natural light and flash light) with the bandwidth from 380nm to 780nm. • Display the various color rendering properties such as CRI, SSI, TLCI, TLMF, and TM-30. • Display the enhanced measurement units. <ol style="list-style-type: none"> (1) Color temperature (K= Kelvin) (2) Color deviation (Δuv) (3) LB/CC index (4) LB/CC Camera filter number (KODAK WRATTEN 2, FUJIFILM, LEE) (5) LB/CC Light filter number (LEE, ROSCO) (6) Illuminance/luminous exposure (ambient light/flash light) (7) TM-30 (Rf, Rg) (8) SSI (comparison with known standards or memorized value) (9) CIE1931 chromaticity (x, y) (10) Hue/Saturation (11) CRI (Ra, R1 to R15) • Various Display modes <ol style="list-style-type: none"> (1) Text mode (2) Spectrum graph/comparison mode (3) CRI/comparison mode (4) TM-30 mode (5) SSI mode (6) TLCI/TLMF mode (7) Filter (Camera/Light) mode (8) Multi Lights mode (9) White balance correction mode

■ Intended Users

The C-800 Series is intended for image makers involved in the photography and motion picture industries, and those who manufacture and rent the light sources which they use. In addition, the C-800 Series is intended for architectural interior lighting design.

■ Disclaimer

The Company shall not be liable for any direct or indirect damage resulting from the failure of this product or its use.

■ Restrictions

There are some cautions and restrictions regarding the use of this product. Please read and understand the following before using the meter.

NOTICE

- The contents of this manual may be subject to change for the product's specification modifications and other reasons without prior notice. We recommend that you download the latest operating manual from our website and use this product.
URL: <https://sekonic.com/downloads/>
 - The safety-related precautions such as «Safety Guide and Maintenance» and «Safety Precautions» conform to the legal and industry standards that were applicable at the time this operating manual was created. Therefore, this manual may not contain the latest information. If you are using the previous operating manual, please download and refer to the latest operating manual.
 - The product may contain printing materials such as cautions related to safety and/or printing errors as a supplement to the operating manual.
 - The contents of this operating manual may be reproduced for non-commercial purposes and for personal use only. However, the reproduced material must contain the copyright notice of our company.
 - The reproduction of all or any part of this document without permission is strictly forbidden.
 - The product concerned and/or this manual may be subject to future changes without prior notification.
 - The screens in this operating manual may differ from the actual displays of the meter you are using. (Colors, letters, etc.)
-

NOTE

- In case of disposing the product, follow the rules of disposal in your area.
-

■ Accompanying Accessories

The following items are included with the meter in the package. Please be sure to check that all noted items are included.

- * If any items are missing, please contact the distributor or the reseller you purchased the meter from.
- * The USB cable (Mini-B connector) is not included in the package. Please obtain this separately.
- * Batteries (two AA) are not included in the package. Please obtain these separately.

Meter



Soft Case

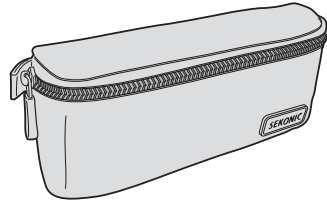

Neck Strap



Quick Guide

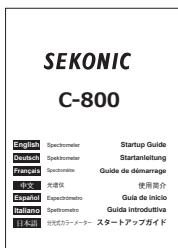

Safety Precaution

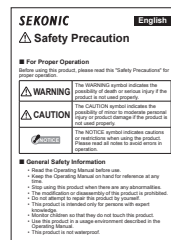

Table of Contents

■ Terminology and Trademarks	
■ Safety Precautions	i
⚠ WARNING	i
⚠ CAUTION	ii
■ CA Prop 65	ii
■ Intended Usage	iv
■ Intended Users	v
■ Disclaimer	v
■ Restrictions	v
■ Accompanying Accessories	vi
1. Parts Designations and Functions	1
■ 1-1 Parts Designations	1
■ 1-2 Parts Functions	2
2. Before Use	3
■ 2-1 Attaching the Strap	3
■ 2-2 Installing the Batteries	4
■ 2-3 Power ON/OFF	5
■ 2-4 Automatic Power OFF Function	9
■ 2-5 Checking the Battery Capacity	10
■ 2-6 Replacing Batteries	11
3. Screen Operation	12
■ 3-1 Screen and Operation	12
■ 3-1-1 Basic Screen and Operation	12
■ 3-1-2 Icon Operation	16
■ 3-1-3 Input of Numbers/Characters	17
■ 3-1-4 Locking and Unlocking the Screen	19
4. Basic Operations	20
■ 4-1 Basic Measurement Flow	20
■ 4-2 Selecting the Measuring Mode	22
■ 4-2-1 Matching Measuring Mode with Light Sources	22
■ 4-2-2 Selecting the Shutter Speed (Flash Modes Only)	24

4-3	Setting the Indication and Items in Measuring Screen	26
4-3-1	Setting Target Color temperature	26
4-3-2	Customizing Display Items in the Measuring Screen	28
4-4	Selecting the Display Mode	30
4-4-1	Displaying in Text [Text] Mode	34
4-4-2	Displaying in Spectrum Graph [Spectrum] Mode	37
4-4-3	Displaying in Spectrum Comparison [Spectrum Comp.] Mode	39
4-4-4	Displaying in Color Rendering Index [CRI] Mode	43
4-4-5	Displaying in Color Rendering Index Comparison [CRI Comp.] Mode	45
4-4-6	Displaying in TM-30 [TM-30] Mode	49
4-4-7	Displaying in Spectral Similarity Index [SSI] Mode	51
	[Standard Light Source Selection]	53
	[Color Temperature Input]	56
	[Memory Recall Selection]	59
4-4-8	Displaying in TLCI or TLMF [TLCI/TLMF] Mode	62
4-4-9	Displaying in Filter [Filter] Mode	66
	[Lighting Filter]	66
	[Camera Filter]	70
4-4-10	Displaying to Compare Light Sources [Multi Lights] Mode	74
4-4-11	Displaying in White Balance Correction Graph [WB Corr.] Mode	81
4-4-12	Displaying Setting [Setting] Screen	83

5. Measuring Light Sources [Measurement Screen] 85

5-1	Measurement Method	85
5-1-1	Balancing Color Temperatures of Light Sources	85
5-2	Measurement in Ambient Light Mode	86
5-3	Measurement in Cordless Flash Mode	89
5-4	Measurement in Cord (PC) Flash Mode	93
5-5	Comparison Function (in Ambient Light Mode only)	98
5-6	When [Over], [Under], [Filter N/A] or red letter is Displayed	100
5-6-1	Display of [Over], [Under], [Filter N/A] or red letter	100
5-6-2	Changing the Light Range	102

6. Measurement Tool [Tool Box] Screen	103
6-1 Setting Preset Contents [Preset Selection] Screen	104
6-2 Using the Memory Function	107
6-2-1 Naming Measurement Being Memorized [Memory Title] Screen	108
6-2-2 Recalling Measurement Results [Memory Recall] Screen	111
6-2-3 Renaming Memory Title [Memory Rename] Screen	116
6-2-4 Deleting Saved Measurement Results [Memory Clear] Screen	119
[Erasing Individual Values]	121
[Erasing the Memory Title]	122
7. Meter Settings [Setting] Screen	124
7-1 Setting Items	124
7-1-1 Item List	126
7-2 Customize	127
7-2-1 Item Specifications	128
7-2-2 Selecting the Shutter Speed Step	129
7-2-3 Selecting the LB Step	132
7-2-4 Selecting the Camera Filter Brand	134
7-2-5 Selecting the Lighting Filter Brand	136
7-2-6 Selecting the White Balance Step	138
7-2-7 Selecting the Unit of Illuminance	140
7-2-8 Selecting the Color Space (Hue/Sat)	142
7-2-9 Selecting the Spectrum Y-axis Scale	144
7-2-10 Selecting the Auto Power Off Time	147
7-2-11 Selecting the Backlight Brightness	149
7-2-12 Selecting the Auto Dimmer Time	151
7-2-13 Selecting the Language	153
7-2-14 Reset Customized Items	155
7-3 Preset Editing	156
7-3-1 Displaying the Preset Selection List	159
7-3-2 Setting the Present Name	161
7-3-3 Setting the Preset Target Color Temperature	163
7-3-4 Setting the LB Index Correction Value	166
7-3-5 Setting the CC Index Correction Value	168

7-4	Dark Calibration	170
7-5	Product Information Display	173
7-5-1	Regulation Display	175
8. Hardware Setting Screen		176
8-1	Adjust Touch Panel	178
8-2	Edit User Information	181
8-3	Factory Setting	183
9. Appendix		186
9-1	Glossary	186
9-2	Filter Types	190
9-3	Specifications	195
9-4	Legal Requirement	200
10. Optional Accessories		201
11. Troubleshooting		202
12. After-sales Services		205
FCC & IC compliance information		206

1. Parts Designations and Functions

1-1 Parts Designations

Front View

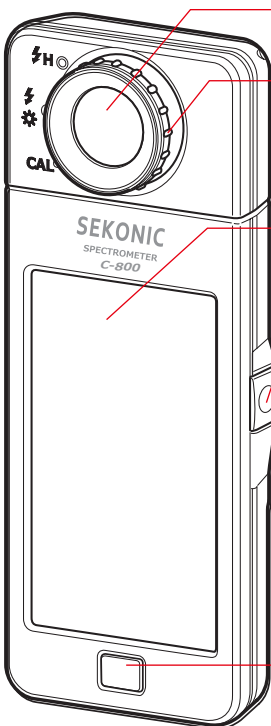

Rear View

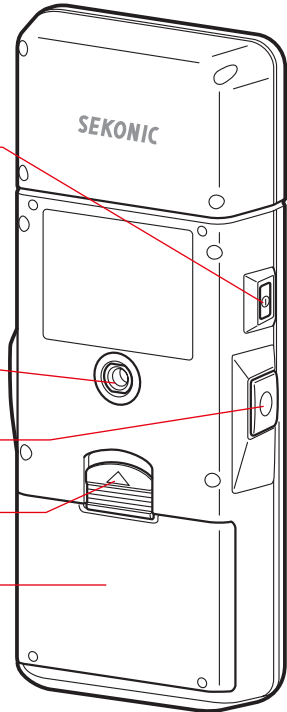

Bottom View

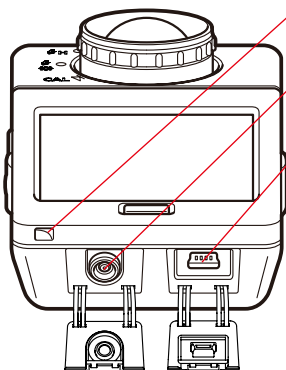

Battery Compartment Section

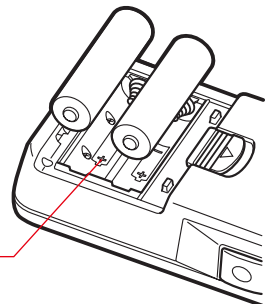

- ① Light Receptor
- ② Light Selection Ring
- ③ Power Button
- ④ Display Panel
- ⑤ Measuring Button
- ⑥ Menu Button
- ⑦ Memory Button
- ⑧ Battery Cover Latch
- ⑨ Battery Cover
- ⑩ Tripod Socket

- ⑪ USB Mini-B Connector
- ⑫ Sync Terminal
- ⑬ Strap Eyelet
- ⑭ Battery Compartment

1-2 Parts Functions

The following table lists the functions of each part.

No.	Part Name	Functions
1	Light Receptor	Point light receptor directly at light source during reading. Head rotates 270 degrees to aid reading.
2	Light Selection Ring	Rotate to select dark calibration, normal measuring range or high range for flash light.
3	Power Button	Press to turn ON/OFF.
4	Display Panel	Displays the setting screens and measuring screens. The built-in touch panel function enables setting, selection or operation by touching the display panel. (➔ P16)
5	Measuring Button	Press for measurement.
6	Menu Button	Press to shift display to Display Mode Selection screen.
7	Memory Button	Press after measuring to save the measured data.
8	Battery Cover Latch	Latch for the battery cover.
9	Battery Cover	Secures the batteries.
10	Tripod Socket	Female mounting threads (1/4-20) for hands free mounting on tripods.
11	USB Mini-B Connector	The USB connector for connecting to the PC with the installed utility and USB bus power. USB terminal: Mini-B-5pin
12	Sync Terminal	Accepts an optional synchro cord when using meter in Cord (PC) Flash Mode.
13	Strap Eyelet	Used to attach the included strap.
14	Battery Compartment	Holds the batteries. Insert the batteries in the correct direction.

2. Before Use

2-1 Attaching the Strap

1. Pass the strap (included) through the outer hole of the Strap Eyelet **13**.
2. Pass the opposite end of the strap through the loop at the end of the strap.

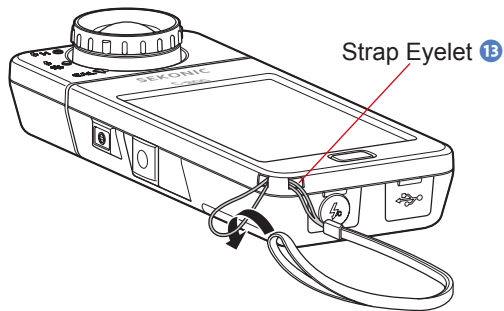

WARNING

Infants or toddlers may accidentally wrap the strap around their neck, so please place it in a location out of their reach. There is a danger of suffocation.

CAUTION

- Infants or toddlers may accidentally grab the strap and swing the product, so please place it in a location out of their reach, as the meter may be damaged by impacts.
- Be careful that the neck strap does not come loose when carrying the product, as the meter may be damaged when dropped.
- This neck strap is made of polyester fiber. Please refrain from using the product if synthetic fibers cause your skin to become irritated, inflamed or itchy in order to prevent worsening your symptoms.

2-2 Installing the Batteries

1. Prepare two AA batteries.
2. Slide the Battery Cover Latch **8** in the direction of the arrow and remove the Battery Cover **9**.
3. Insert the batteries according to the "+" and "-" symbols in the Battery Compartment **14**.

* As shown in the diagram below, please note both positive sides of the batteries are facing in the same direction.

4. While lining up the two tabs on the Battery Cover **9**, press the Battery Cover **9** back into place from above.

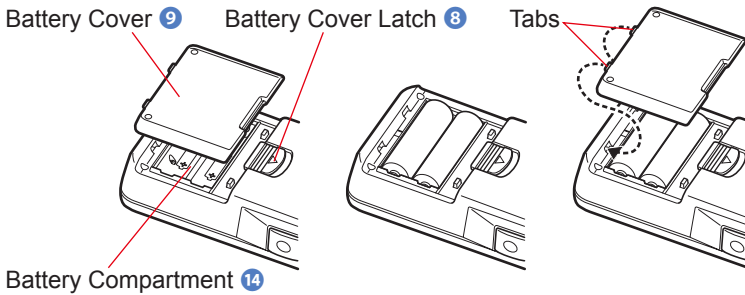

WARNING

Do not place batteries in open flames, attempt to short, disassemble, apply heat to, or recharge them (except rechargeable batteries). They may burst and cause fires, serious injury, or damage to the environment.



CAUTION

- Use the manganese or alkaline batteries.
- Do not use batteries with any other rating than the one specified. Also, do not mix old and new batteries.
- Please insert the batteries minus "-" side first. When removing the batteries, remove them plus "+" side first.
- If the meter will not be used for an extended period of time, it is recommended to remove the batteries to avoid possible damage caused by battery leaking.

2-3 Power ON/OFF

Power ON

1. Turn the Light Selection Ring ② to set to the dark calibration position **CAL** ().
2. Press the Power Button ③ .
The meter will turn on and the Startup screen will be displayed (for 2 seconds).

Light Selection Ring ②

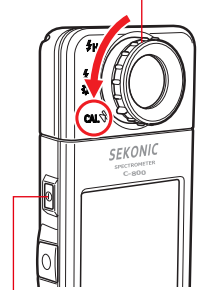

Power Button ③

Startup Screen



NOTICE

- The blue lettered "SEKONIC" logo screen is displayed after battery replacement and 24 hours after power OFF.
- The meter is executing a memory check while the blue progress bar is moving on the Logo Screen, so please do not turn OFF the power, as doing so may lead to damage.

Logo Screen



NOTE

- If the LCD screen shows no display, check if the batteries are installed properly (Pos/Neg positioning) and have enough capacity.
- You can reduce start up time by simply tapping the screen when the Startup screen appears.

3. Select the language. (Appears only when turned ON for the first time)

The Language Selection screen is displayed. Select the language to use.

Language Selection Screen



Language Selection Confirmation Screen



A blue highlight will appear behind the selected button.

4. Press the [OK] to select the language.

The language can be switched at any time. (→ P153)

5. Dark calibration.

The C-800 measuring system must be calibrated before use. Turn Light Selection Ring to calibration indication. "Dark calibration in progress. Please wait" and the status bar will appear while calibrating. The Measuring screen will appear when operational.

Dark Calibration Process Screen

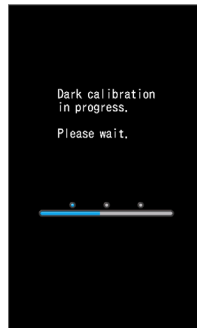

Dark calibration is performed when there is a big change in temperature between turning power OFF and ON.

Except the cases above, dark calibration after power ON is skipped.

NOTICE

- When the Light Selection Ring ② is not set to the dark calibration position, the message "Please set Light Selection Ring for dark calibration." is displayed. Set the Light Selection Ring ② to the dark calibration position **CAL** (▶) to calibrate the system.

Dark Calibration Position Confirmation Screen



- If dark calibration is not successful, "Dark calibration failed. Please check Light Selection Ring position." is displayed. Set the Light Selection Ring ② to the dark calibration position **CAL** (▶) to calibrate the system.

Dark Calibration Confirmation Screen



6. Press the Measuring Button ⑤ to measure.

Turn the Light Selection Ring ② to select the range.

When measuring ambient light, make sure to select Range L (⚡) (▶).

When measuring flash units, select Range L (⚡) (▶) or Range H (⚡) (▶) depending on the brightness of the flash. (▶ P100, ▶ P102)

NOTICE

When the Measuring Button ⑤ is pressed at the dark calibration position, the message "Measurement failed. Please check Light Selection Ring position." is displayed. Set the Light Selection Ring ② to the correct position and the Measuring screen will be displayed.



**NOTE**

Measurements and display will take longer in light levels below 30lx. The LCD illumination will normally switch off during measurements to avoid influence to measurements.

Power OFF

1. Press and hold the Power Button **3** for 1 second or longer.

The meter will turn OFF.

**NOTICE**

Please wait 3 seconds between repeated power on and power off sessions.

**NOTE**

All settings and measurements made during use are saved in memory even after the meter is powered off.

2-4 Automatic Power OFF Function

To save battery capacity, the meter will automatically turn off 5 minutes (default setting) after the last button is pressed.



NOTE

- All measurements, settings and indications are saved in memory even after the meter has automatically turned off. When the power is turned ON, they will be displayed again.
- The default setting of Auto Power Off is 5 minutes. Other settings or “No auto power off” can be selected in the Customize of Setting screen. (➔ P147)
- If, while in transport, the Power Button ③ is inadvertently and continually pressed in, the meter will turn ON for about 1 minute and then turn automatically turn OFF to save battery power.

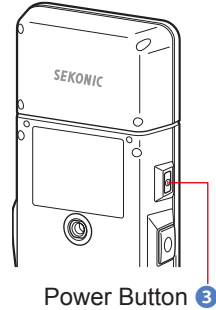

Power Button ③

2-5 Checking the Battery Capacity

When the power is turned ON, the LCD screen will show the battery capacity indicator.



Sufficient battery life remaining.



Adequate battery life remaining.



Have a spare battery ready.



Replace the battery immediately.

Battery capacity indicator

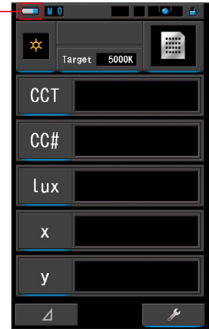

NOTE

- When battery power is low and the meter is turned ON, the LCD screen will appear and then turn off immediately. This is an indication that the batteries are depleted and should be replaced immediately.
Having spare batteries on hand is recommended.
- When the meter is continuously used at room temperature, the battery life should last 8 hours (based on Sekonic testing methods).

2-6 Replacing Batteries

- Always turn off the power before replacing batteries.
If you replace batteries while the power is turned on, the measured values that are obtained during operations are not saved. Also, this may cause a failure.
- If an unexpected display appears on the LCD during battery replacement or measurement, ie. settings other than selected, or if the meter does not respond when a button is pressed, remove the batteries, wait at least 10 seconds, and then re-install them.

3. Screen Operation

3-1 Screen and Operation

3-1-1 Basic Screen and Operation

The touch-screen display enables selecting Display Modes and settings with the touch of your finger.

Measuring Screen

The Measuring screen is displayed after the meter is turned ON and the dark calibration is complete.

On the Measuring screen, it is possible to select the Measuring mode or change the measuring condition. Touch the icons with blue under-bar to change the setting. To change the Display Modes, refer to each explanation of Display Modes.



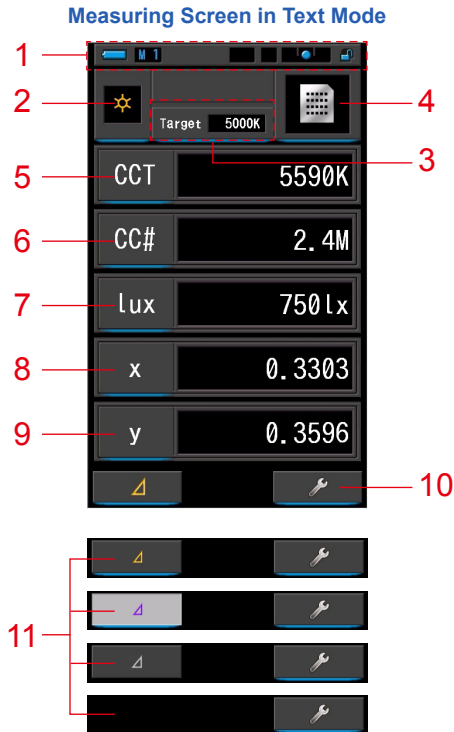



* Pressing the Menu Button **6** on the meter returns the meter to the Display Mode Selection screen.

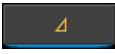

* The display changes depending on the set measuring mode.

* For this description, all icons and menus are displayed.

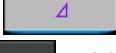
Item List

No.	Part Name	Description
1	Status Bar	Displays the setting contents. (➡ P14)
2	[Measuring Mode] Icon	Displays the current Measuring Mode. (➡ P22) Touch the icon to switch to the Measuring Mode Selection screen.
3	[Target] Indication	Displays the target color temperature. (➡ P26) Touch the icon to switch to the Target Color Temperature Input screen.
4	[Display Mode] Icon	Displays the current Display Mode. (➡ P30) Touch the icon to switch to the Display Mode Selection screen.
5 ~ 9	[Display Item] Indication	Touch the icon to switch to the Display Item Selection screen. (➡ P28)
10	[Tool Box] Icon	Switches to the Tool Box screen. (➡ P103)
11	[Delta] Icon (in Ambient Light Mode only)	 Displayed when comparison measurement can be performed.
		 When there is no reference measurement value, the icon is disabled.
		 When comparison measurement cannot be performed, the (Δ) icon is not displayed.
		When  is touched, the displayed measurement is memorized and Comparison Function is activated. When holding the Measuring Button 5, the value differences of the memorized items (except filter names) and the current reading will be displayed. When the Measuring Button 5 is released, the display will revert to memorized values of the first reading. (A graph displays the reference values) When  is touched, the icon returns to  and the last measured values are displayed. Comparison Function is cancelled when the power is turned OFF. Note Caution: When the Comparison Function icon is displayed, the Memory Button 7 is disabled.

 **NOTE**

When values are outside the display or measurement range, [Under], [Over] or [Filter N/A] is displayed.

Under: Displayed if value is lower than measurement range (too dark) or color temperature value is too low.













Over: Displayed if value is higher than measurement range (too bright) or color temperature value is too high.

Filter N/A: Displayed if there is no more combination of Filter name and number.

Status Bar



* For this description, all icons and menus are displayed.

No.	Part Name	Description	
1	Battery Capacity Indicator		Sufficient battery life remaining.
			Adequate battery life remaining.
			Have a spare battery ready.
			Replace the battery immediately.
			Appears when powered by USB.
2	Memory Count		Displays the number of measured data stored in memory. The number in memory is displayed until 99 to the right of the mark.
3	Preset Selection		Displays the preset number when a preset is selected.
4	Temperature Fluctuation Warning		When the mark appears, the referenced environment temperature is fluctuating, and accurate measurement may not be possible. Please perform dark calibration.
5	Light Selection Ring Status Indicator		Appears when the Light Selection Ring ② is selected by the dark calibration position.
			Appears when the Light Selection Ring ② has range "L" selected.
			Appears when the Light Selection Ring ② has range "H" selected.
6	Key Lock Status Indicator		Appears when the screen is unlocked.
			Appears when the screen is locked. When the screen is locked, touch panel operations are disabled.

Tool Box Screen

The following setting can be performed after touching the [Tool Box ()] icon on the measuring screen.

* All icons are displayed for explanatory purposes for the Tool Box screen. It is not the default.

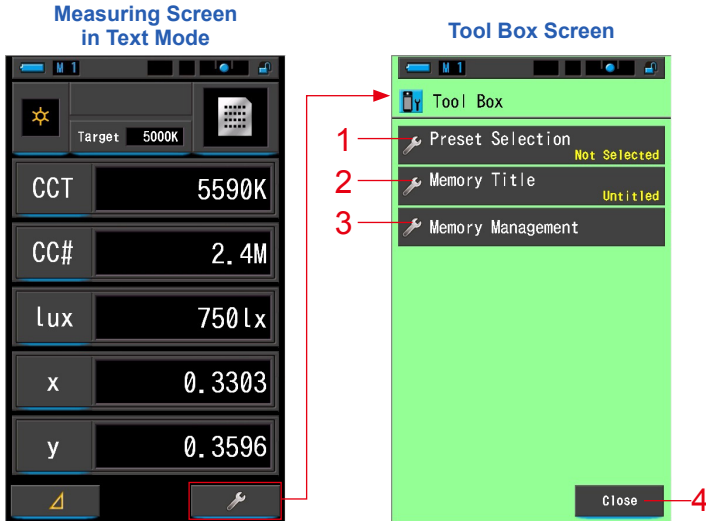

[Tool Box: Item List]

No.	Part Name	Description
1	Preset Selection	Switches to the Preset Selection screen. (➡ P104)
2	Memory Title	Switches to the Memory Title Input screen. (➡ P108)
3	Memory Management	Switches to the Memory Management screen. (➡ P111)
4	[Close] Button	Closes the Tool Box screen and returns to the Measuring screen.

3-1-2 Icon Operation

Touch Operation

Touch the icons on screen to perform various operations.

(Ex.) Measuring Screen in Text Mode

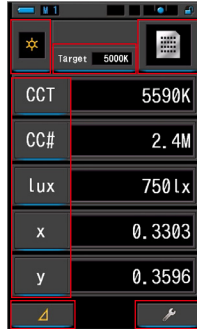

Touch-enabled Icons

Icons with blue under-bar indicate which icons are operational.



Touch-enabled Icons



Touch-disabled Icons

Slide Operation

Slide your finger tip up or down over a value to change the value amount.
Sliding your finger over scroll bar provides fast navigation of large menus.

(Ex.) Shutter Speed Selection Screen

Scroll Selection

Slide a finger up or down on the setting value areas to change setting values.

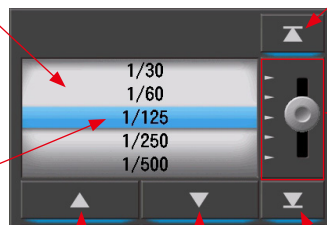

Top Icon

Touch to advance to the lowest value.

Scroll Bar

Touch and slide up or down to scroll settings.

One Step Icon

Touch the Up or Down icon to advance one position.

Bottom Icon

Touch to advance to the highest value.

* Blue bar indicates the value selected.

3-1-3 Input of Numbers/Characters

You can input numbers and characters.

Numeric Number Input Screen

(Ex.) Target Color Temperature Input Screen

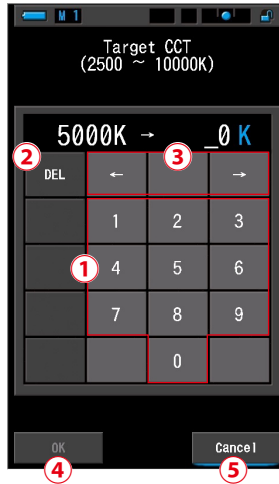

Numeric Number Method

No.	Key	Description
①	0-9	Value displayed on screen when key touched.
②	Delete	Deletes input value at cursor position.
③	← →	Moves input position.
④	OK	Confirms input value and returns to previous screen.
⑤	Cancel	Cancels input value and returns to previous screen.

Character Input Screen

Figure Input Screen

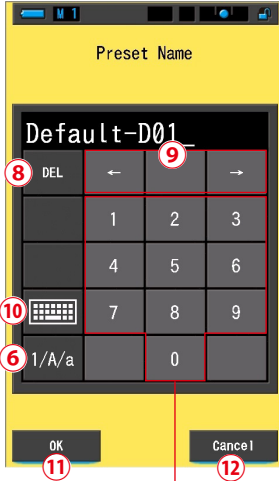

⑦ (Figures)

Upper Case Input Screen

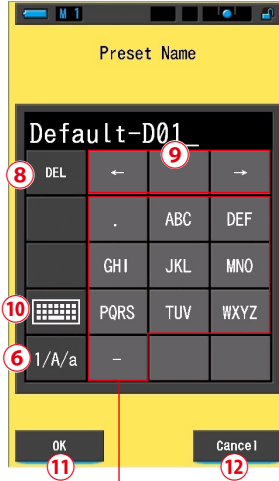

⑦ (Upper Case Letters)

Lower Case Input Screen

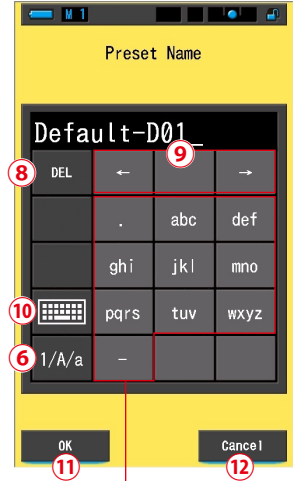

⑦ (Lower Case Letters)

Keypad (Upper Case Input Screen)

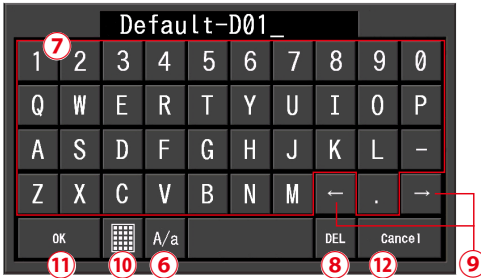

Keypad (Lower Case Input Screen)

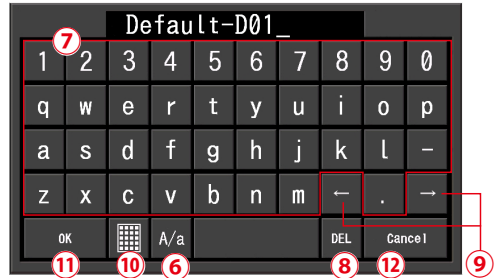

Input Method of Characters and Numbers

No.	Key	Description
⑥	1/A/a	Shifts between numbers/upper case letters/lower case letters.
⑦	0-9, ABC, abc, hyphen, period	Value displayed on screen when key touched. Repeated touching of the same button for alphabet (ABC/abc) will change the alphabet character in order.
⑧	Delete	Deletes the character at the cursored position.
⑨	← →	Moves input position.
⑩	Keypad	Shifts between Standard Keypad and Qwerty Keypad.
⑪	OK	Confirms input value and returns to previous screen.
⑫	Cancel	Cancels inputting and returns to previous screen.

3-1-4 Locking and Unlocking the Screen

You can lock the screen to prevent misoperation.

When the screen is locked, touch operation is disabled.

However, the Memory Button **7**, Measuring Button **5**, and Power Button **3** are still operational.

The screen will stay locked even when power is turned OFF and ON.

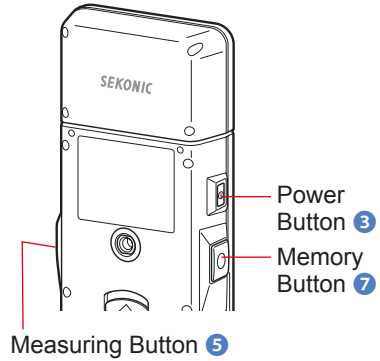

To Lock

In any measuring mode, press and hold the Menu Button **6** to see the Locked icon [] appear at the upper right corner of the LCD screen.

Function Icons cannot be operated while the screen is locked.

The Locked icon [] will appear for approximately 1 second at the center of the screen when function icons are touched or MENU button **6** is pressed.

* This lock function can be set in the Measuring screens only.

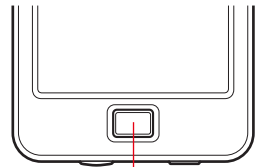

Menu Button **6**

To Unlock

When the Menu Button **6** is pressed and held again, the screen is unlocked.

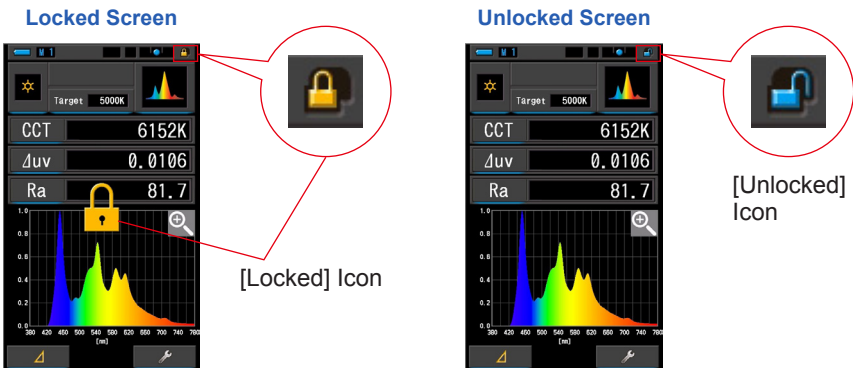

4. Basic Operations

4-1 Basic Measurement Flow

The basic operations and screens are as follows. Measurements and measurement changes are operated from the Measuring screen.

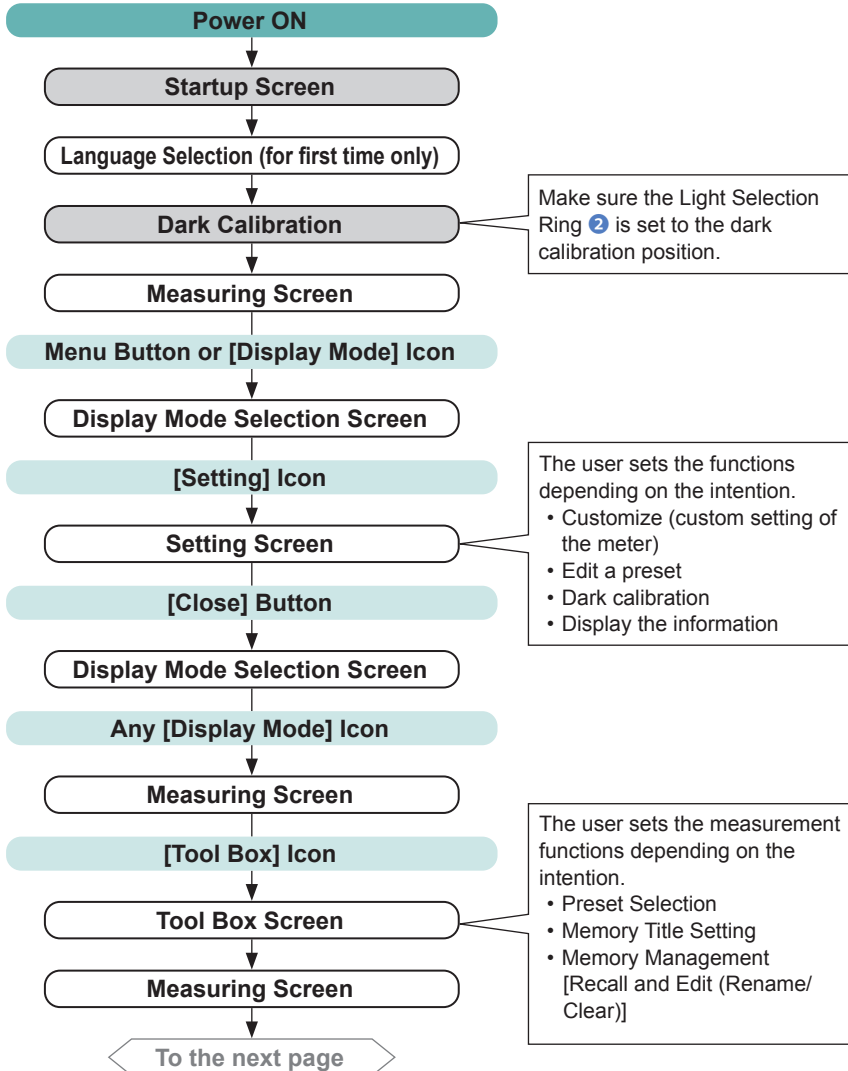

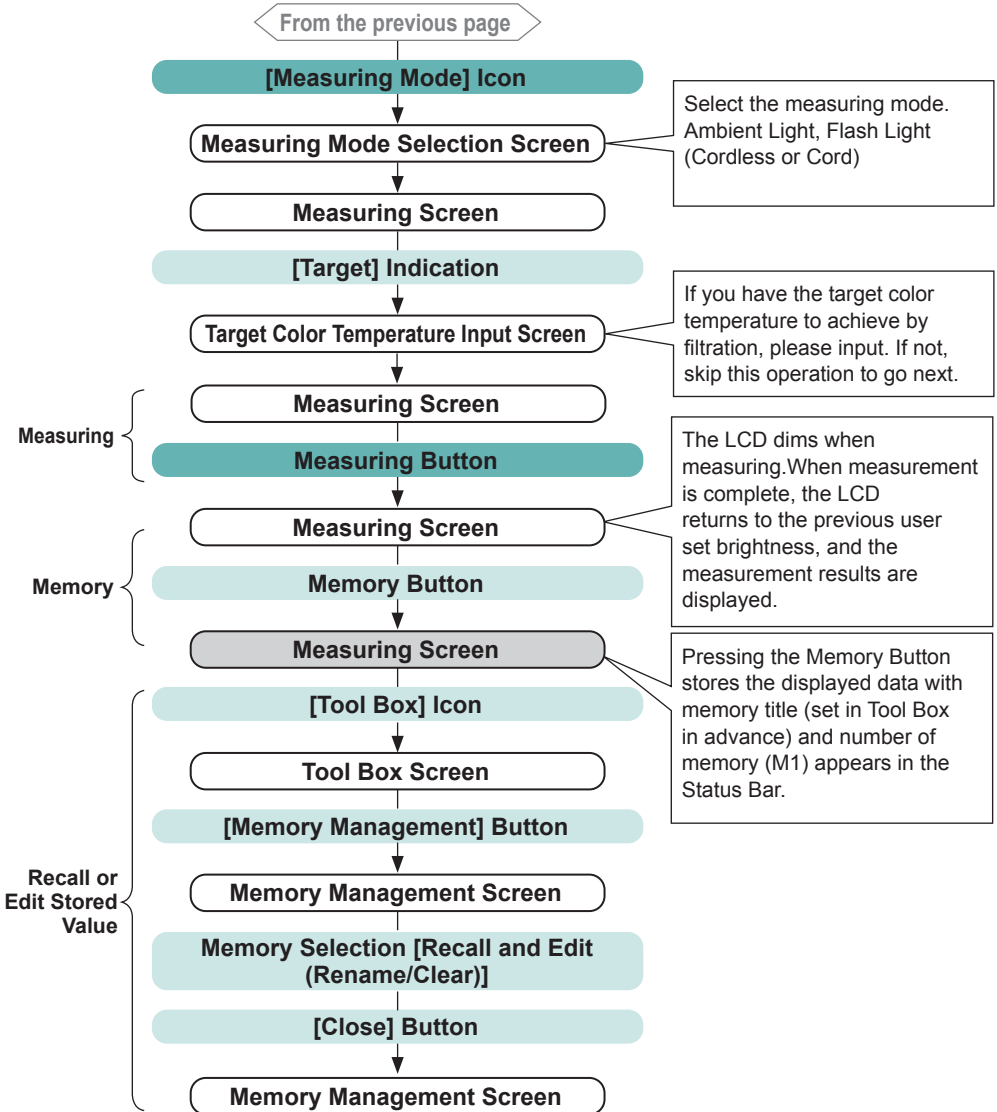

4-2

Selecting the Measuring Mode

4-2-1

Matching Measuring Mode with Light Sources



Select the Measuring Mode to use.

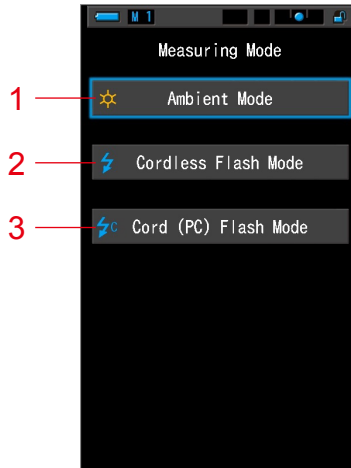

If you change the Measuring Mode, the currently displayed measurement is cleared.

Measuring Mode Selection Screen



No.	Measuring Mode	Icon	Description
1	Ambient Light Mode		Measures continuous light such as sunlight, tungsten, fluorescent, and LED lights. (➔ P86)
2	Cordless Flash Mode		Detects flash light without meter-flash connection after Measuring Button pressed to arm meter (for 90 seconds) and flash fired separately. (➔ P89)
3	Cord (PC) Flash Mode		Detects flash light with PC (synchro) cord meter-flash connection. (➔ P93)

Operation

1. Touch the [Measuring Mode] icon in the upper left corner of the screen.
The Measuring Mode Selection screen will be displayed.

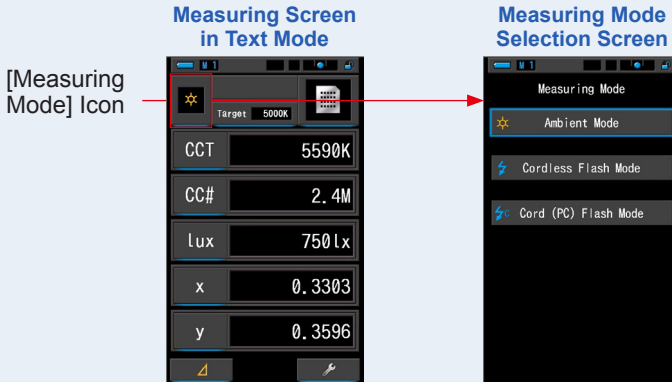

2. Touch an icon to select the Measuring mode.

Select the desired Measuring mode.

Making selection returns the display to previous Measuring screen using selected mode.

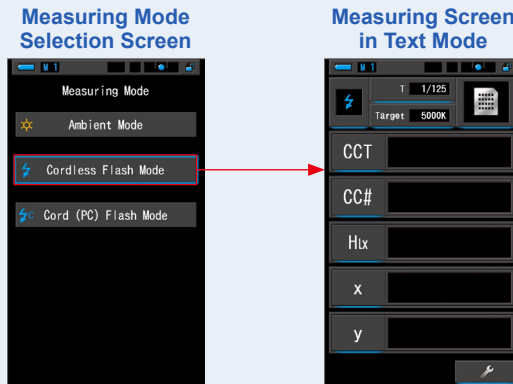

Ex.) Ambient Light Mode → Cordless Mode



NOTE

- Ambient light includes continuous light sources such as natural light (sunlight), tungsten lamps, fluorescent lamps, LED lights, etc.
- Flash light includes brief and intense burst of light sources such as electronic flash units or flash bulbs.

4-2-2 Selecting the Shutter Speed (Flash Modes Only)

Set a shutter speed that is appropriate for the intended flash measurement.

Operation

1. Touch the [T (Shutter Speed)] indication.

(Ex.) Cordless Flash Mode Measuring Screen in Text Mode



2. Select the desired shutter speed.

Shutter Speed Screen

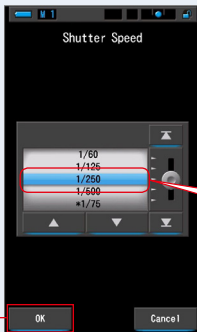

[OK] Button

[Shutter Speed 1/125]

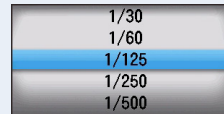

[Shutter Speed 1/250]

3. Touch the [OK] button.

Confirms the settings, and returns to the previous Measuring screen.

To cancel the setting, touch the [Cancel] button.

The shutter speed is set.

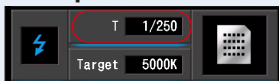



Shutter speeds can be selected by the item [Shutter Speed Step] in page 1 of "Customize" in the Setting screen.

You can choose 1 step, 1/3 step, and 1/2 steps. (→ P129)

Shutter Speed Selections

1 Step (Factory default)	1/3 Step	1/2 Step
1s	1s	1s
1/2	0.8	0.7
1/4	0.6	1/2
1/8	0.5	1/3
1/15	0.4	1/4
1/30	0.3	1/6
1/60	1/4	1/8
1/125	1/5	1/10
1/250	1/6	1/15
1/500	1/8	1/20
*1/75	1/10	1/30
*1/80	1/13	1/45
*1/90	1/15	1/60
*1/100	1/20	1/90
*1/200	1/25	1/125
*1/400	1/30	1/180
	1/40	1/250
	1/50	1/350
	1/60	1/500
	1/80	*1/75
	1/100	*1/80
	1/125	*1/90
	1/160	*1/100
	1/200	*1/200
	1/250	*1/400
	1/320	
	1/400	
	1/500	
	*1/75	
	*1/80	
	*1/90	
	*1/100	
	*1/200	
	*1/400	

* Special shutter speed setting.



Measuring data will be erased when the shutter speed setting is changed.

4-3

Setting the Indication and Items in Measuring Screen

4-3-1

Setting Target Color temperature

Use this setting to establish a "target" color temperature for camera and light source filtration selection.

The target color temperature is displayed in the upper central part of the Measurement screen.

Operation

1. Touch the [Target] indication on the Measurement screen.

(Ex.) Measuring Screen in Text Mode

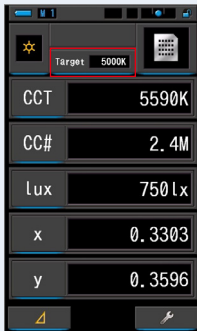

2. Enter the Target color temperature value.

The current target color temperature value is displayed in the left side, and input color temperature value is displayed in the right side.

Target CCT Input Screen

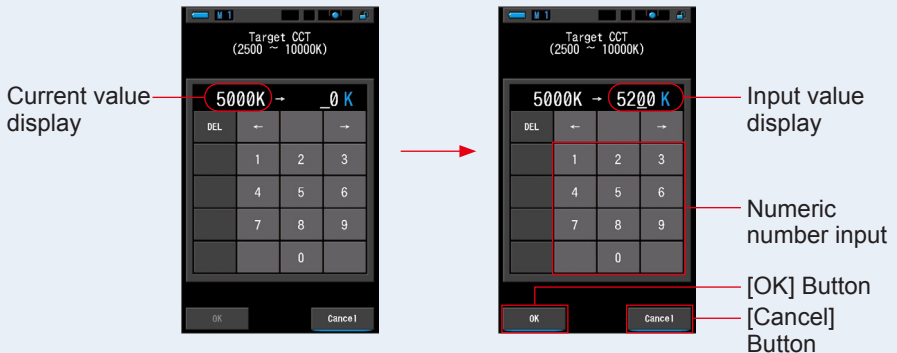

3. Touch the [OK] button.

Confirms input value and returns to previous Measurement screen.

To cancel the setting, touch the [Cancel] button.

The target color temperature is set.



NOTE

- Set the meter's target color temperature to the same color temperature set on your camera for manual white balance. Some digital cameras have the recommended color temperature for true color reproduction. For details, please refer to your digital camera's operating manual.
- You can set the color temperature from 2,500K to 10,000K in steps of 10K.
- When you frequently use multiple reference color temperatures, use preset for convenience. (➔ P104)

4-3-2 Customizing Display Items in the Measuring Screen

You can customize displayed information to see exactly what you need in single view.

Operation

1. Touch the [Display Item] indication on the Measuring screen.
The Display item library screen will be displayed. (⇒ P35)
2. Select the items to be displayed.
Selected items and the values will be displayed.

Measuring Screen
Text Display

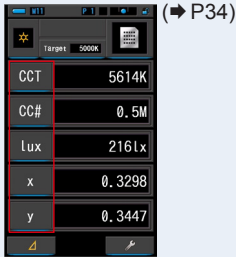

Measuring Screen
Spectrum Display

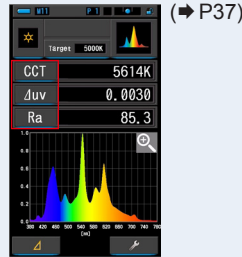

Measurement Screen
CRI Display

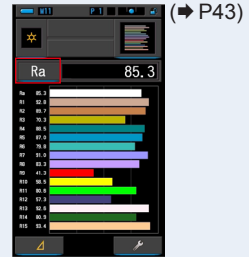

Display Item List

No.	Indication	Display Item Name	Description
1	CCT	Color Temperature Display	Displays correlated color temperature.
2	Δuv	Color Temperature Deviation	Displays deviation from the black-body radiation.
3	Lux, fc	Illuminance *	Displays illuminance in lux or foot-candle.
4	Hlx, Hfc	Exposure *	Displays exposure in lux-second or foot-candle-second.
5	CCi	CC Index Correction	Displays the CC correction value in CC index.
6	CC#	CC Filter Number	Displays the CC corrected value in total value of CC filter number.
7	CCcf	CC Camera Filter Correction	Displays the CC correction value in the compensation filter name. The filter brand is selected in the Measuring screens and Setting Mode.
	CClf	CC Lighting Filter Correction	
8	LBi	LB Index Correction	Displays the LB correction value in LB index.
9	LBcf	LB Camera Filter Correction	Displays the LB correction value in the compensation filter name. The filter brand is selected in the Measuring screens and "Customize" in the Setting screen.
	LBlf	LB Lighting Filter Correction	

* Models sold in some countries do not display illuminance and exposure in "fc (fc·s)" due to legal restrictions.

No.	Indication	Display Item Name	Description
10	Rf	Fidelity Index	Displays the Fidelity index of TM-30 in the value from 0 to 100.
11	Rg	Gamut Index	Displays the Gamut index of TM-30 in the value from 0 to 200.
12	SSIt	SSI Tungsten	Displays the SSI index in the value from 0 to 100 in comparison with CIE Tungsten (3200K).
13	SSId	SSI Daylight	Displays the SSI index in the value from 0 to 100 in comparison with CIE D55 (5500K).
14	SSI1	SSI #1	Displays the SSI index in the value from 0 to 100 in comparison with #1 selected light source (yellow graph) in SSI mode.
15	SSI2	SSI #2	Displays the SSI index in the value from 0 to 100 in comparison with #2 selected light source (red graph) in SSI mode.
16	TLCI	TLCI	Displays the TLCI index in the value from 0 to 100.
17	TLMF	TLMF	Displays the TLMF index in the value from 0 to 100 in comparison with selected memorized value.
18	x	Chromaticity coordinate x	CIE1931 Chromaticity coordinate x
19	y	Chromaticity coordinate y	CIE1931 Chromaticity coordinate y
20	Hue	Hue	Displays the color (i.e. red, green, blue) in the value from 0 to 359 degrees.
21	Sat	Saturation	Displays the saturation in the value from 0 to 100.
22	Ra	Average CRI	Displays the average value of CRI R1 to R8 in the value of from 0 to 100.
23	R1 ~ R15	CRI Number	Displays Individual CRI number from R1 to R15 in the value of from 0 to 100.

4-4 Selecting the Display Mode

Touching an icon on the Display Mode Selection screen displays lighting information in different ways to suit your needs.

* Pressing the Menu Button **6** on the meter returns to the Display Mode Selection screen.

Display Mode Selection Screen

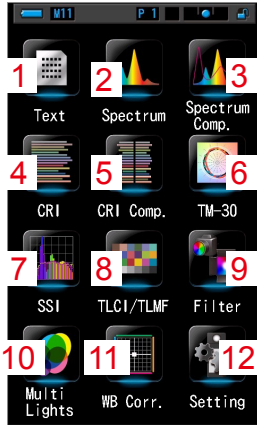

1 Text

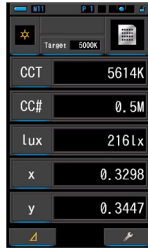

2 Spectrum

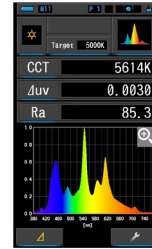

3 Spectrum Comparison

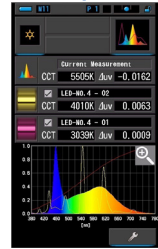

4 CRI

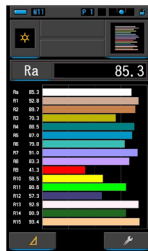

5 CRI Comparison

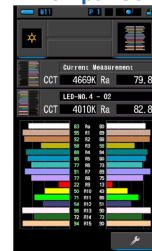

6 TM-30



7 SSI



8 TLCI/TLMF

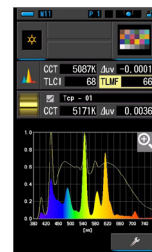

9 Filter

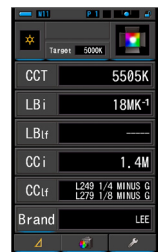

10 Multi Lights

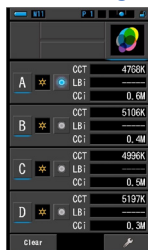



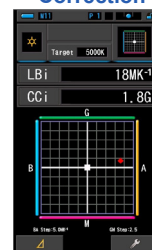









11 White Balance Correction



12 Setting

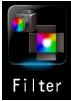

Display Mode Icons List

No.	Icon	Display Mode Name	Description
1	 Text	[Text] Icon	Displays user-selected 5 items in numeric values. (➔ P34)
2	 Spectrum	[Spectrum] Icon	Displays 3 user-selected values and spectrum distribution graph. (➔ P37)
3	 Spectrum Comp.	[Spectrum Comparison] Icon	Compares the current measurement value and up to 2 memorized values in the spectrum distribution graph. (➔ P39)
4	 CRI	[CRI] Icon	Displays the average CRI (Ra) or individual CRI (R1 ~ R15) numerically. Each CRI is displayed in a graph. (➔ P43)
5	 CRI Comp.	[CRI Comparison] Icon	Compares the current measurement value and memorized value to show the color temperature and average CRI (Ra). Also, individual CRI (R1 to R15) is displayed in a graph. (➔ P45)
6	 TM-30	[TM-30] Icon	Displays four current measurement values (Rf, Rg, CCT, Δuv) and color vector graphic. (➔ P49)
7	 SSI	[SSI] Icon	Compares the current measurement value and up to 2 reference values (color temperature and Δuv), and displays SSI index with the SSI spectrum graph. (➔ P51)
8	 TLCI/TLMF	[TLCI/TLMF] Icon	Displays the current measurement values and memorized values (in color temperature and Δuv), TLCI and TLMF with spectrum graph. (➔ P62)
9	 Filter	[Filter] Icon	Displays correction values and camera filter names or lighting filter names required to adjust measured light source to target color temperature. (➔ P66)
10	 Multi Lights	[Multi Lights] Icon	Displays and compares up to four measurement values on the same screen, Displays the correction value from the selected measurement value. (➔ P74)
11	 WB Corr.	[White Balance Correction] Icon	Displays correction values in LB index and CC index between the current measurement value and the target color temperature in a white balance graph. (➔ P81)
12	 Setting	[Setting] Icon	Displays Setting screen. (➔ P83)

* 1 ~ 11 are the Measuring screen.

Operation

1. Touch the [Display Mode] icon on the Measuring screen or press Menu Button 6 on the meter.

The Display Mode Selection screen will be displayed. (→ P30)

Display modes from No.1 to 11 are for measurement.

Display mode No.12 is for settings.

2. Touch a desired Display Mode icon to display.

The Measuring screen in selected Display Mode appears on the screen.

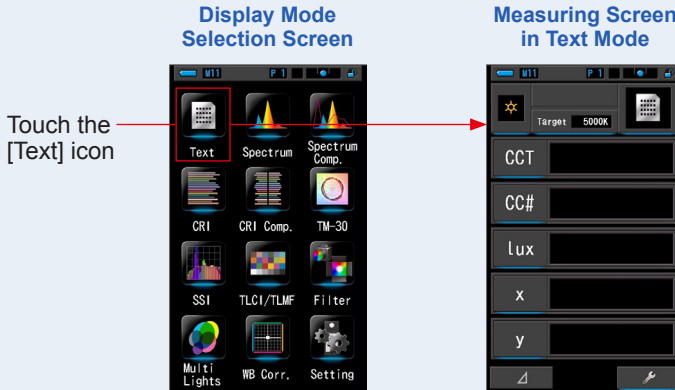

3. Press the Measuring Button 5 to measure.

The Light Selection Ring 2 should be set to L (⚡ ()) when taking ambient light measurements.

When measuring flash units, select Range L (⚡ ()) or Range H (⚡ ()) depending on the brightness of the flash. (→ P100, → P102)

Measurements are now displayed.

Light Selection Ring 2

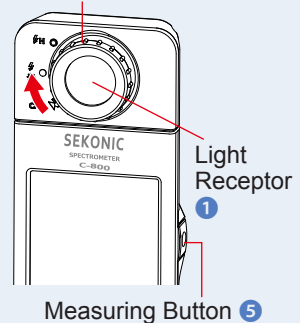

NOTE

- To measure the color temperature of a light source properly, point Light Receptor 1 directly at light source during reading.
- Measurements and display will take longer in light levels below 30lx. The LCD illumination will normally switch off during measurements to avoid influence to measurements.

4. Measurement result appears on the Measuring screen (Text Mode).

Measuring Screen in Text Mode



5. Memorize the measurement results.

To record measurements, press Memory Button  . (➔ P107)

4-4-1 Displaying in Text [Text] Mode

Displays five user-selected items in numeric value.

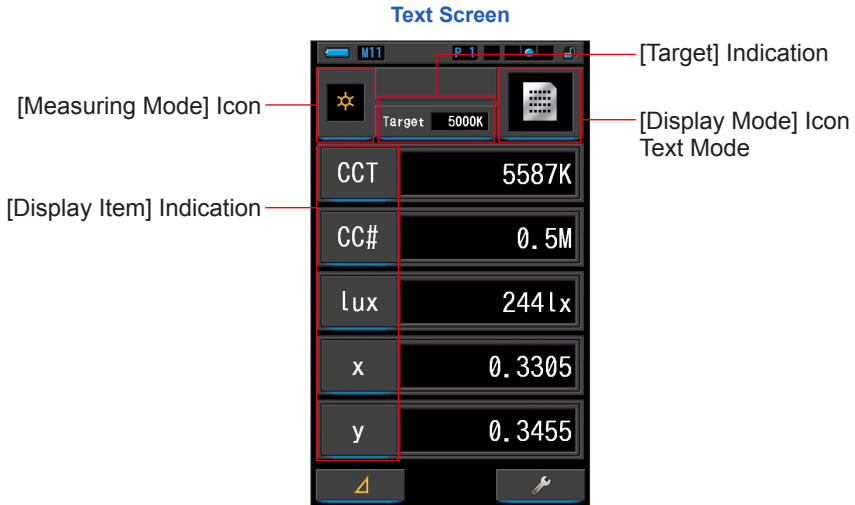

Operation

1. Touch the [Text] icon on the Display Mode Selection screen.

A Text screen will be displayed. (⇒ P30)

2. Touch the [Measuring Mode] icon.

The Measuring Mode Selection screen will be displayed. Select the desired measuring mode to use. (⇒ P22)

3. Touch the [Target] indication.



Target CCT Input screen will be displayed. (⇒ P26)

Set the desired color temperature number.

4. Touch the [Display Item] indication to change.

The Display Item Library screen will be displayed.

The currently selected display item will be encircled in blue.

5. Touch the desired Display Item indication and [OK] button.

The currently selected display item will be encircled in blue.

Pressing [OK] button confirms the settings, and returns to the Measuring screen.

To cancel the setting, touch the [Cancel] button.

Text Screen

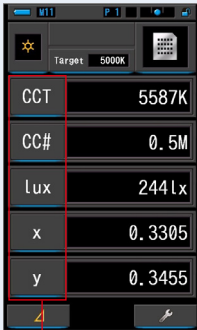

Touch [Display Item] indication you want to change.

Display Item Library Screen

in Ambient Light Mode
Page 1



in Flash Light Mode
Page 1

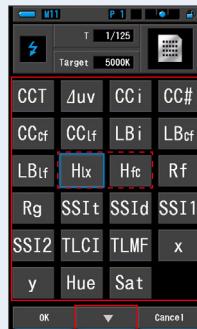

In Both Modes
Page 2

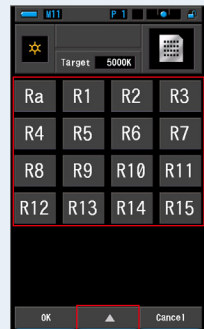

To page 2

To page 1

Touch the desired Display Item.

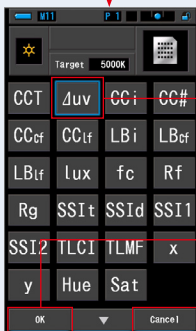

Indication will be encircled in blue.

[OK] Button

[Cancel] Button



New Display Item appears.

* Models sold in some countries do not display "fc (fc-s)" due to legal restrictions.

6. Press the Measuring Button 5 to measure.

The Light Selection Ring 2 should be set to L (⚡ (🔵)) when taking ambient light measurements.

When measuring flash units, select Range L (⚡ (🔵)) or Range H (⚡⚡ (🔵)) depending on the brightness of the flash. (➔ P100, ➔ P102)

Measurements are now displayed.

Light Selection Ring 2

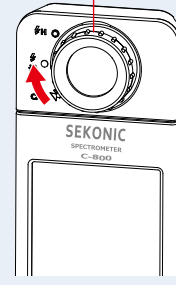

Measuring Button 5



NOTE

- It may take longer time in case of taking measurement under low light (under 30lx).
It is not defect that LCD backlight becomes darker while taking measurement to avoid any influence.
- When using the Hue & Saturation function, it is possible for the hue value to turn from white text to red text. This is an indication that the saturation of the light measured is too low for an accurate hue measurement. You will find this if a light has a saturation below 30%.

7. Memorize the measurement results.

To record measurements, press Memory Button 7. (➔ P107)

4-4-2 Displaying in Spectrum Graph [Spectrum] Mode

Displays three user-selected values and spectral distribution graph.

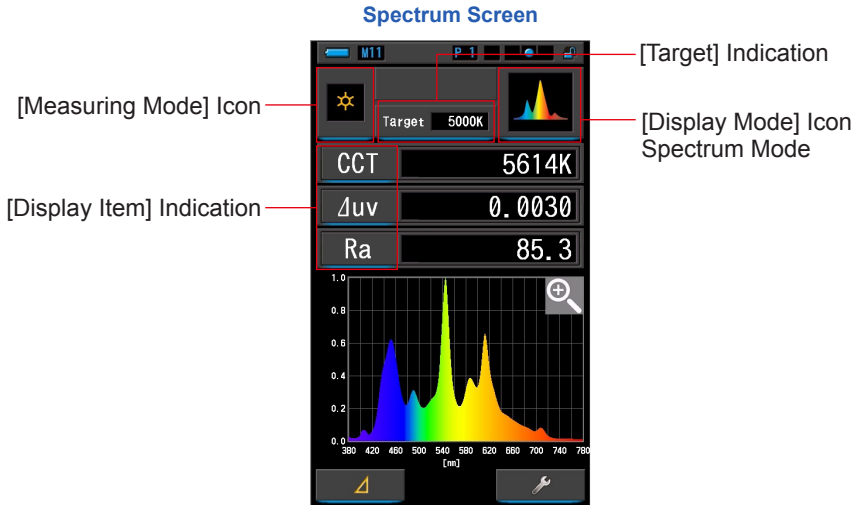



Operation

1. Touch the [Spectrum] icon on the Display Mode Selection screen.
A spectrum distribution graph screen will be displayed. (⇒ P30)
2. Touch the [Measuring Mode] icon.
The Measuring Mode Selection screen will be displayed. Select the desired measuring mode to use. (⇒ P22)
3. Touch the [Target] indication.
Target CCT Input screen will be displayed. (⇒ P26)
Set the desired color temperature number.
4. Touch the [Display Item] indication to change.
The Display Item Library screen will be displayed. (⇒ P35)
Touch the desired Display Item and [OK] button.

5. Press the Measuring Button 5 to measure.

The Light Selection Ring 2 should be set to L () when taking ambient light measurements.

When measuring flash units, select Range L () or Range H () depending on the brightness of the flash. (➔ P100, ➔ P102)

Measurements are now displayed.

Light Selection Ring 2

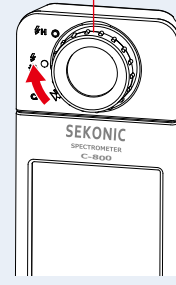

Measuring Button 5



NOTE

Measurements and display will take longer in light levels below 30lx. The LCD illumination will normally switch off during measurements to avoid influence to measurements.

6. Touch the [Magnifying Glass (+)] icon on the screen.

The spectrum distribution graph will be enlarged.

The enlarged graph is displayed on the whole screen (landscape).

To return to the Spectrum screen, touch the [Magnifying Glass (-)] icon on the enlarged spectrum distribution graph.

Spectrum Screen

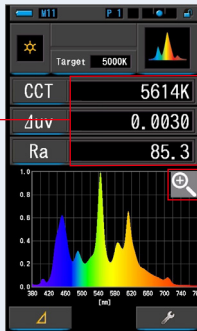

Measurement results are displayed.

Spectrum Distribution Graph Enlarged Display

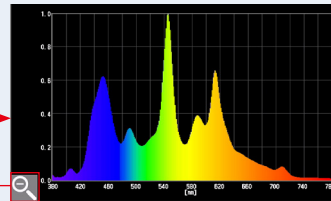

NOTICE

When the enlarged graph is displayed, measurement cannot be performed.



NOTE

The maximum display value of the Y-axis can be selected by the item [Spectrum Y-axis Scale] icon in page 2 of Setting. (➔ P144)

7. Memorize the measurement results.

To record measurements, press Memory Button 7 . (➔ P107)

4-4-3

Displaying in Spectrum Comparison [Spectrum Comp.] Mode

Compares the current measurement value and up to 2 memorized values as yellow and/or red lines in the spectrum distribution graph.

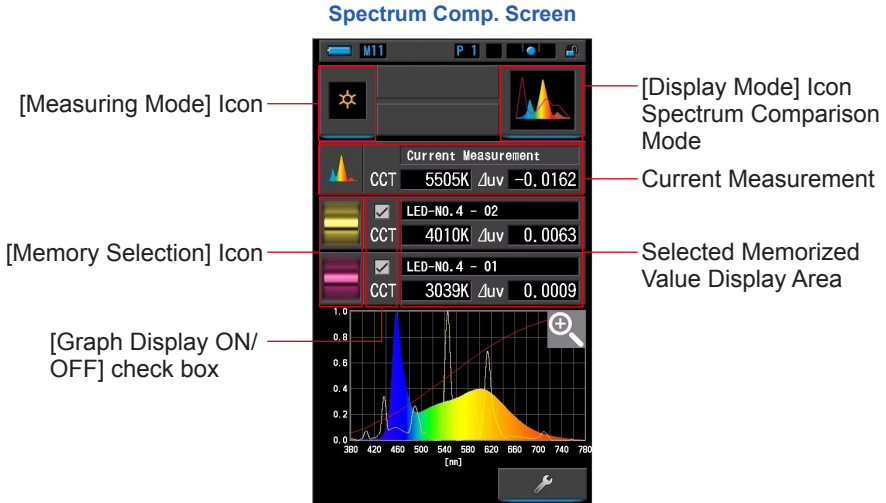

Operation

1. Touch the [Spectrum Comp.] icon on the Display Mode Selection screen.



The Spectrum Comp. screen will be displayed. (→ P30)

2. Touch the [Measuring Mode] icon.

The Measuring Mode Selection screen will be displayed. Select the desired measuring mode to use. (→ P22)

3. Press the Measuring Button ⑤ to measure.

The Light Selection Ring ② should be set to L () when taking ambient light measurements.

When measuring flash units, select Range L () or Range H () depending on the brightness of the flash. (→ P100, → P102)

Measurements are now displayed.

Light Selection Ring ②

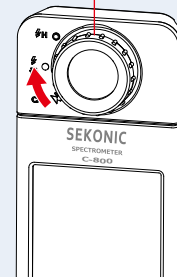

Measuring Button ⑤



Measurements and display will take longer in light levels below 30lx. The LCD illumination will normally switch off during measurements to avoid influence to measurements.

4. The current measurement is displayed at the top of display area with rainbow colored spectrum graph.

5. Touch the [Memory Selection] icon.

The [Spectrum Comp. Memory Recall] screen will be displayed.

Spectrum Comp.
Screen

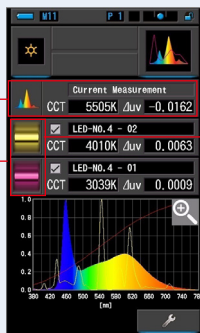

Current Measurement

[Memory Selection] Icon

Spectrum Comp.
Memory Recall Screen

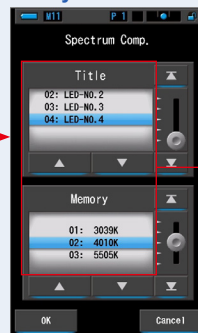

Memory Selection Area

If no measurements have been memorized, the pop-up screen appears to indicate no memorized value.

Memory Selection Pop-up Screen

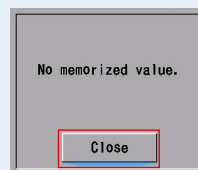
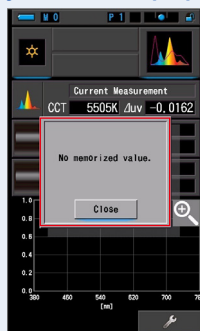

After you confirmed the message "No memorized value.", touch the [Close] button. Returns to the Spectrum Comp. screen.

After memorizing several values, select the memorized value again.

6. Select the desired memory data to compare the spectrum.

When a title is selected, the memory linked to the title will be displayed. Select a memorized reading for display and comparison.

To select a title and a memory, match them with the blue background positions.

Spectrum Comp. Memory Recall Screen

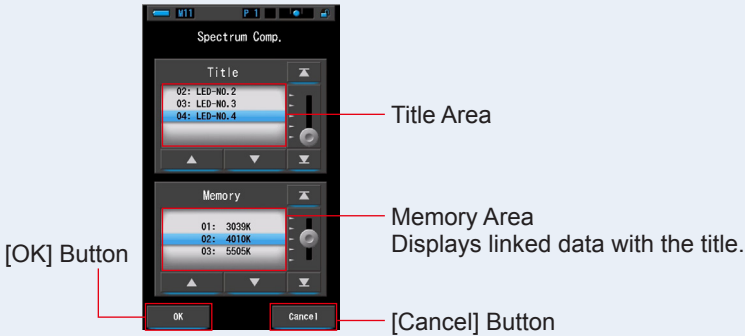

7. Touch the [OK] button.

Confirms the setting and returns to the Spectrum Comp. screen.

To cancel the setting, touch the [Cancel] button.

8. The titles and measurements of the selected memories will be displayed on the Spectrum Comp. screen.

Memory Title Display

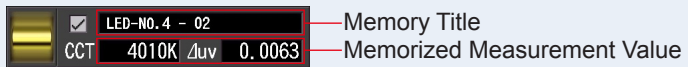

9. Line graphs will be displayed in the spectrum graph.

Touch the [Graph Display ON/OFF] check box to hide/show a line graph on the screen.

* shows line. hides line.

Spectrum Comp. Screen

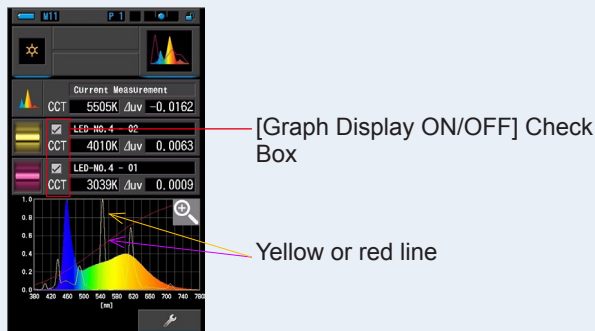

10. Touch the [Magnifying Glass (+)] icon.

The spectrum comparison graph will be enlarged.

The enlarged graph is displayed on the whole screen (landscape).

To return to the Spectrum Comp. screen, touch the [Magnifying Glass (-)] icon on the enlarged spectrum comparison graph.

Spectrum Comp. Screen

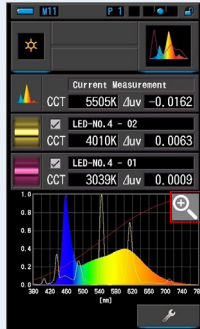

Spectrum Comparison Graph Enlarged Display

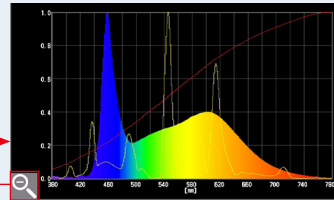

NOTICE

When the enlarged graph is displayed, measurement cannot be performed.

NOTE

- The maximum display value of the Y-axis can be selected in the [Spectrum Y Axis Scale] in "Customize" on page 2 of Setting screen. (➔ P144)
- During Spectrum Comparison Mode, the Comparison Function is not available and [] button will be hidden.

11. Memorize the measurement results.

To record only current measurements, press Memory Button  . (➔ P107)

4-4-4 Displaying in Color Rendering Index [CRI] Mode

Displays the selected average CRI (Ra) or individual CRI (R1 ~ R15) numerically. Each CRI is also displayed in a graph.

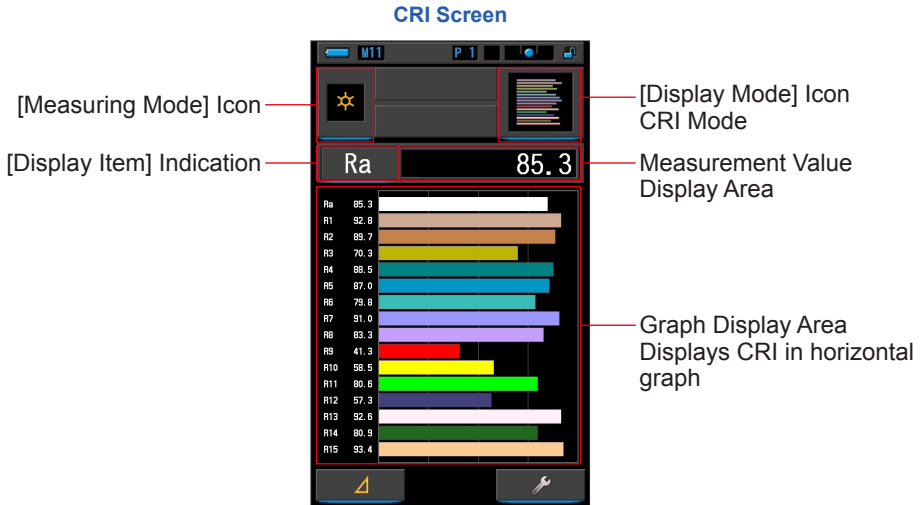



Operation

1. Touch the [CRI] icon on the Display Mode Selection screen.
The CRI screen will be displayed. (→ P30)

2. Touch the [Measuring Mode] icon.
The Measuring Mode Selection screen will be displayed. Select the desired Measuring mode to use. (→ P22)

3. Press the Measuring Button ⑤ to measure.

The Light Selection Ring ② should be set to L () when taking ambient light measurements.

When measuring flash units, select Range L () or Range H () depending on the brightness of the flash. (→ P100, → P102)

Measurements are now displayed.

Light Selection Ring ②

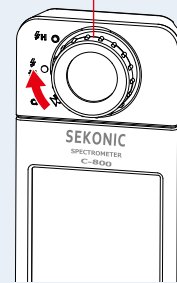

Measuring Button ⑤



- Graph display areas Ra, R1 to R15 are always displayed.
- Measurements and display will take longer in light levels below 30lx. The LCD illumination will normally switch off during measurements to avoid influence to measurements.
- Ra is the averaged value from R1 to R8 only. R9 to R15 are not included in the Ra.

4. Touch the [Display Item] indication to change.

The Display Item Library screen will be displayed.

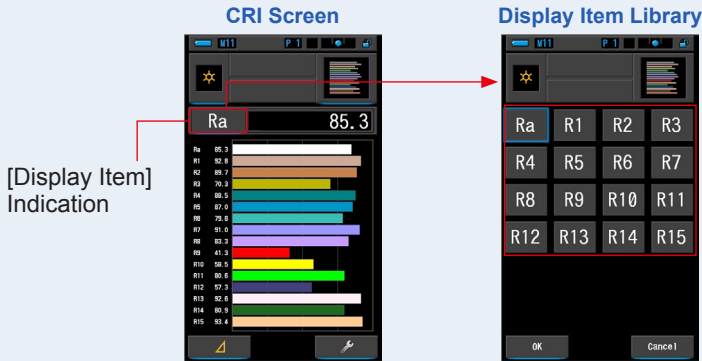

5. Touch the desired Display Item.

Select the item to display above the graph.
Indication will be encircled in blue.

6. Touch the [OK] button.

Confirms the setting and returns to the CRI screen.

To cancel the setting, touch the [Cancel] button.

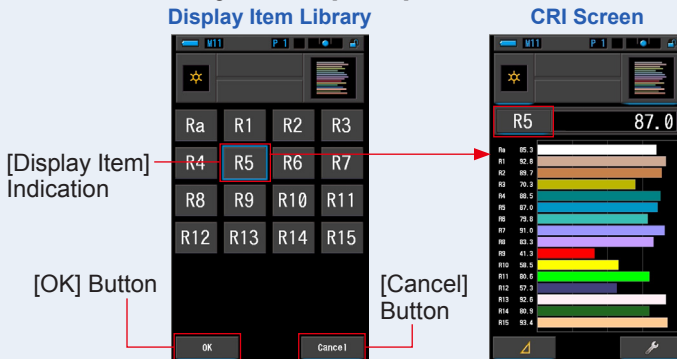

7. Memorize the measurement results.

To record only current measurements, press Memory Button  . (→ P107)

4-4-5 Displaying in Color Rendering Index Comparison [CRI Comp.] Mode

Compares the current measurement value and memorized value to show the color temperature and average CRI (Ra). Also individual CRI (R1 to R15) is displayed in each graph.

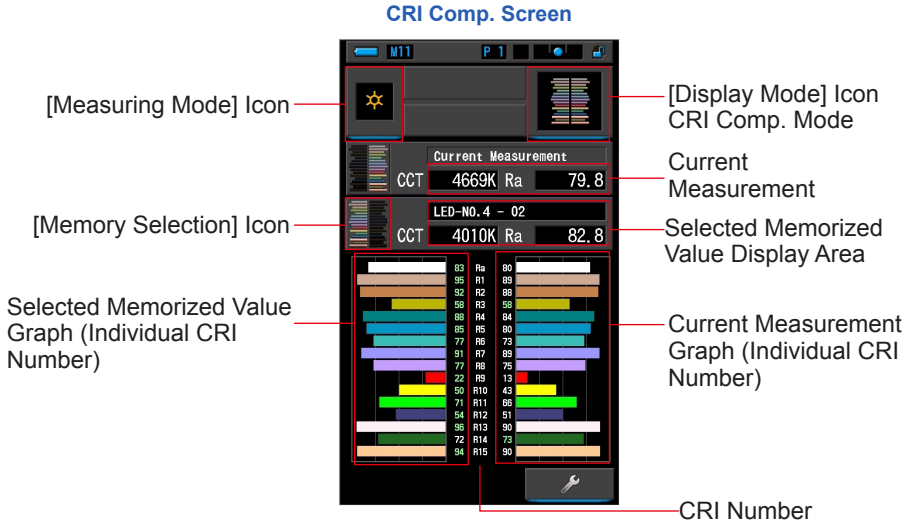

Operation

1. Touch the [CRI Comp.] icon on the Display Mode Selection screen.

The CRI Comp. screen will be displayed. (→ P30)

2. Touch the [Measuring Mode] icon.

The Measuring Mode Selection screen will be displayed. Select the desired measuring mode to use. (→ P22)

3. Press the Measuring Button ⑤ to measure.

The Light Selection Ring ② should be set to L () when taking ambient light measurements.

When measuring flash units, select Range L () or Range H () depending on the brightness of the flash. (→ P100, → P102)

Measurements are now displayed.

Light Selection Ring ②

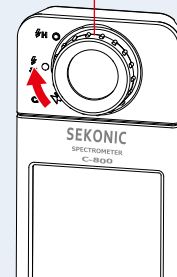

Measuring Button ⑤



- Graph display areas Ra, R1 to R15 are always displayed.
- Measurements and display will take longer in light levels below 30lx. The LCD illumination will normally switch off during measurements to avoid influence to measurements.
- Ra is the averaged value from R1 to R8 only. R9 to R15 are not included in the Ra.

4. Current measurement appears with the graph in the right side of display.

5. Touch the [Memory Selection] icon.

The [CRI Comp. Memory Recall] screen will be displayed.

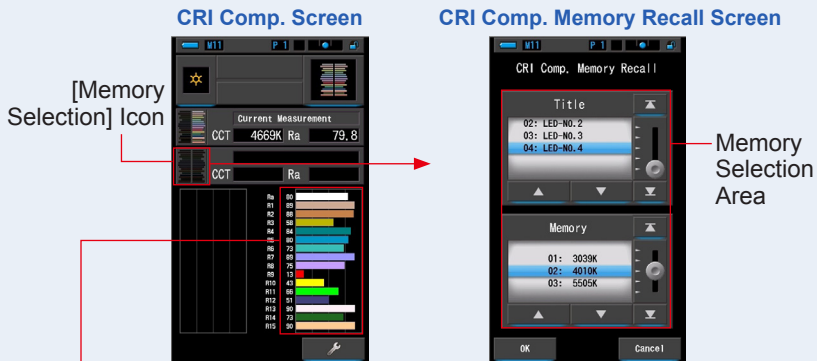

Current Measurement Graph
(Individual CRI Number)

If no measurements have been memorized, the pop-up screen appears to indicate no memorized value.

Memory Selection Pop-up Screen

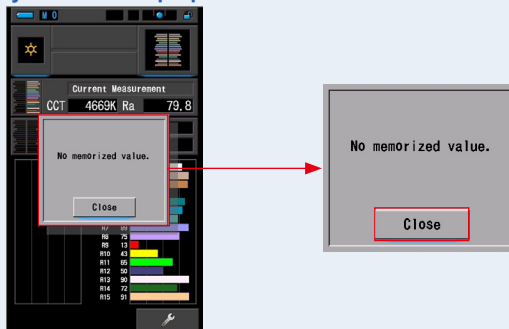

After you confirmed the message "No memorized value.", touch the [Close] button.
Returns to the CRI Comp. screen.

After memorizing several values, select the memorized value again.

6. Select the desired memorized value to compare the CRI.

When a title is selected, the memory linked to the title will be displayed. Select a memorized reading for display and comparison.

To select a title and a memory, match them with the blue background positions.

CRI Comp. Memory Recall Screen

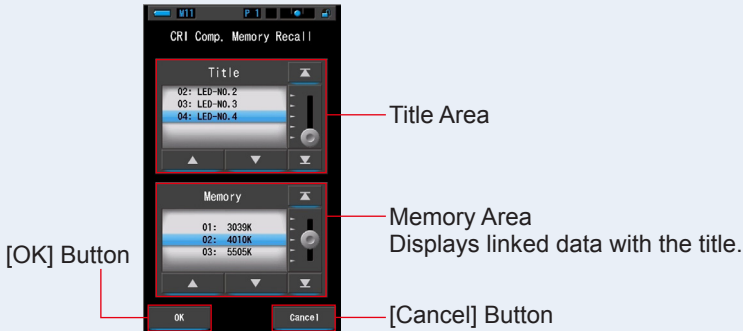

7. Touch the [OK] button.

Confirms the setting and returns to the CRI Comp. screen.

To cancel the setting, touch the [Cancel] button.

8. The titles and measurements of the selected memories will be displayed on the CRI Comp. screen.

Memory Title Display

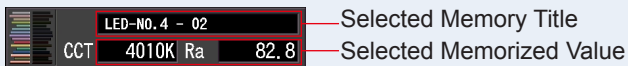

9. Selected memorized value and graph are displayed on the CRI Comp. screen

Current measurement appears on the right side of graph, and selected memorized value appears on the left side of graph.

CRI Comp. Screen

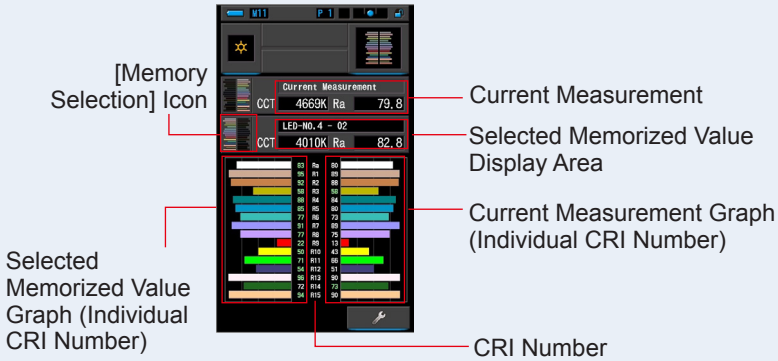

10. Memorize the measurement results.

To record only current measurements, press Memory Button **7** . (→ P107)

4-4-6 Displaying in TM-30 [TM-30] Mode

Displays four current measurement values (Rf, Rg, CCT, Δuv) and color vector graphic. (→ P188)

The C-800 with latest firmware shows TM-30-18.

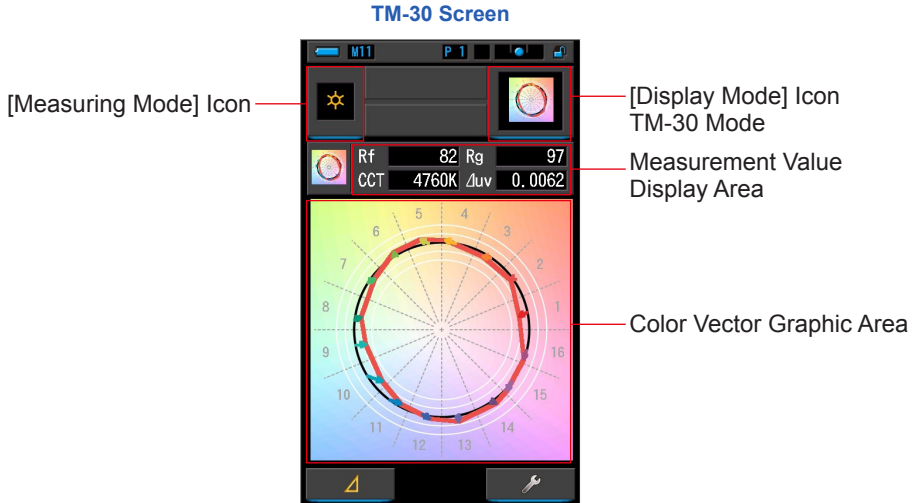

Operation

1. Touch the [TM-30] icon on the Display Mode Selection screen.



A TM-30 distribution graph screen will be displayed. (→ P30)

2. Touch the [Measuring Mode] icon.

The Measuring Mode Selection screen will be displayed. Select the desired measuring mode to use. (→ P22)

3. Press the Measuring Button ⑤ to measure.

The Light Selection Ring ② should be set to L () when taking ambient light measurements.

When measuring flash units, select Range L () or Range H () depending on the brightness of the flash. (→ P100, → P102)

Measurements are now displayed.

Light Selection Ring ②

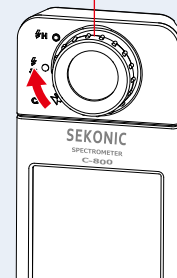

Measuring Button ⑤



Measurements and display will take longer in light levels below 30lx. The LCD illumination will normally switch off during measurements to avoid influence to measurements.

4. Current measurements and color vector graphic are displayed.

Default Display Items are Rf, Rg and CCT, Δuv .

Color vector graphic is the visual representation of hue and chroma shifts around the hue circle divided by 16.

Color vector graphic shows the current measurement in the red line.

The standard light source is displayed in black solid line, and arrow shows the difference for current measurement.

White circles with radius shows Rg80, 90, 110 and 120.

Numbers from 1 to 16 represent hue-angle bins divided by 16 in 22.5 degree increment, which assign from 1 of red to 16 of reddish purple.

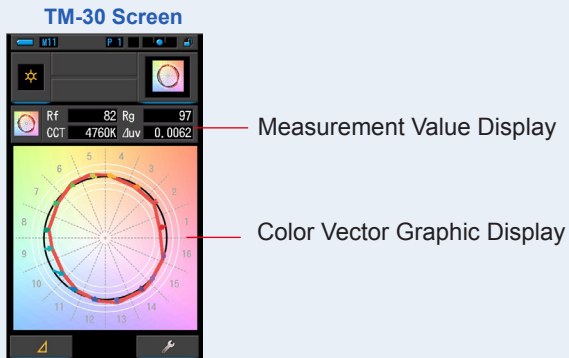

5. Memorize the measurement results.

To record measurements, press Memory Button **M** . (→ P107)

4-4-7 Displaying in Spectral Similarity Index [SSI] Mode

Compares the current measurement value and up to 2 reference values (color temperature and Δuv), and displays SSI index with the SSI spectrum graph. Reference light source can be set in three ways from standard illuminant, color temperature input or memory recall. (➔ P188)

SSI Screen

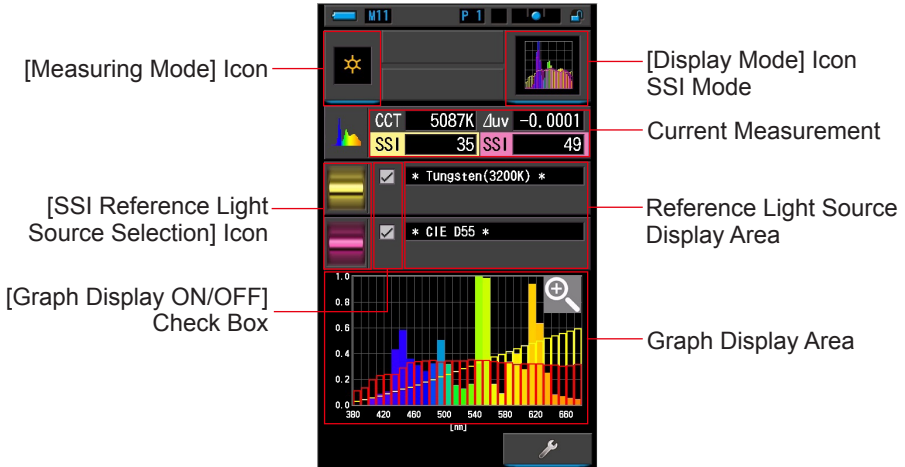

Operation

1. Touch the [SSI] icon on the Display Mode Selection screen.

The SSI screen will be displayed. (➔ P30)

2. Touch the [Measuring Mode] icon.

The Measuring Mode Selection screen will be displayed. Select the desired measuring mode to use. (➔ P22)

3. Press the Measuring Button ⑤ to measure.

The Light Selection Ring ② should be set to L (⚡) when taking ambient light measurements.

When measuring flash units, select Range L (⚡) or Range H (⚡H) depending on the brightness of the flash. (➔ P100, ➔ P102)

Measurements are now displayed.

Light Selection Ring ②

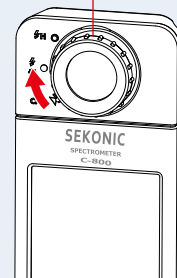

Measuring Button ⑤



Measurements and display will take longer in light levels below 30lx. The LCD illumination will normally switch off during measurements to avoid influence to measurements.

4. The current measurement is displayed in the graph display area.

5. Touch the [Select SSI Reference] icon.

The [Select SSI Reference Light] screen will be displayed.

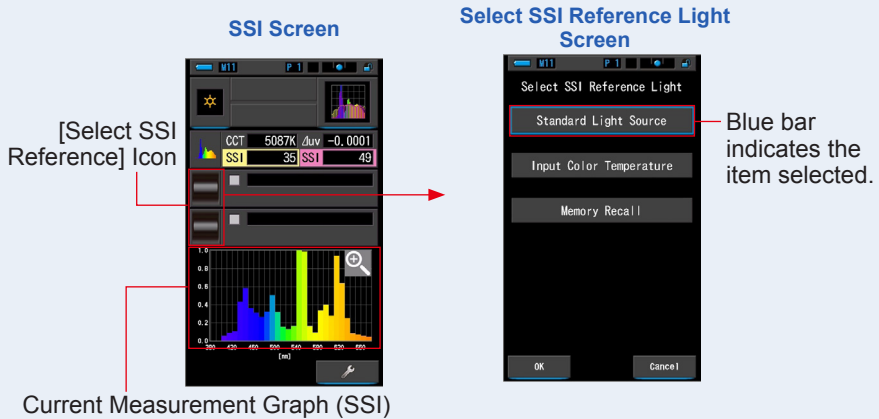

6. There are three ways to select the [Select SSI Reference Light].

Select the item to compare from three options; [Select SSI Standard Light Source], [Input SSI Color Temperature] and [SSI Memory Recall].

Select SSI Standard Light Source Screen



Input SSI Color Temperature Screen



SSI Memory Recall Screen

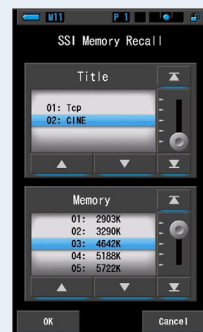

[Standard Light Source Selection]

You can select the reference light source from standard illuminants.

There are [Tungsten 3200K] and supplementary standard illuminant [CIE D55] as the SSI standard light source, [CIE A(2856K)] and [CIE D65] as CIE standard illuminant, and [CIE D50] and [CIE D75] as the CIE supplementary standard illuminant.

1. Touch the [Standard Light Source] indication on the Select SSI Reference Light screen.

The Select SSI Standard Light Source screen will be displayed.

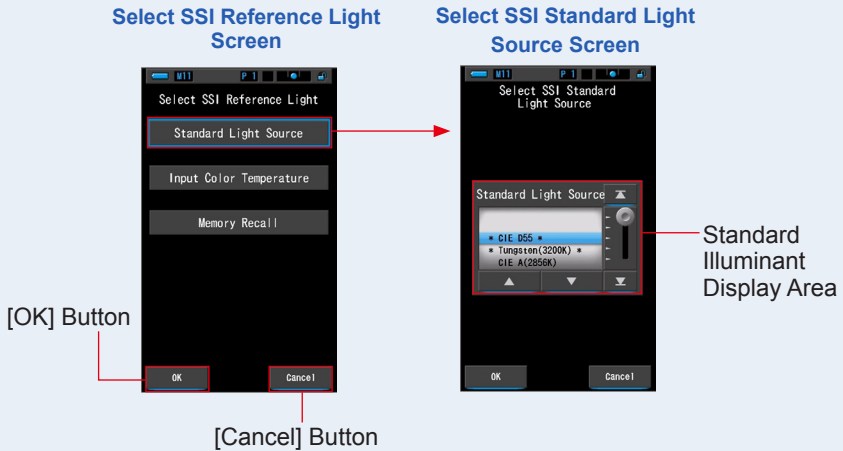

2. Select the desired standard illuminant to compare.

To select the standard illuminant, match it with the blue background position.

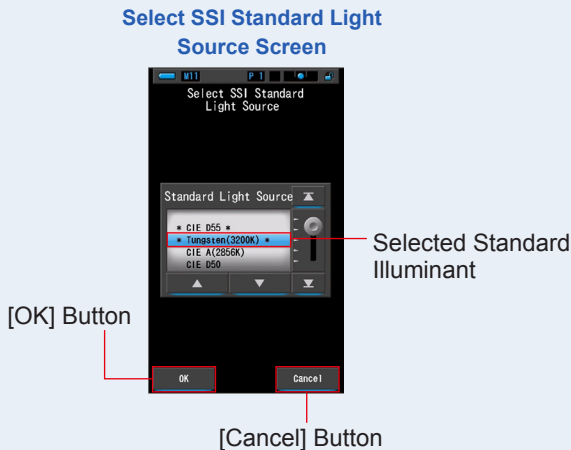

3. Touch the [OK] button.

Confirms the setting and returns to the SSI screen.

To cancel the setting, touch the [Cancel] button.

4. The selected standard illuminant will be displayed in the reference light source display area on the SSI screen.

You can select up to two reference light sources.

Reference Light Source Display Area



5. SSI value of current measurement to compare with the reference light source will be displayed.

Current Measurement Display Area



6. Yellow and Red line graphs will be displayed in the SSI spectrum graph.

Touch the [Graph Display ON/OFF] check box to hide/show a line graph on the screen.

* shows line. hides line.

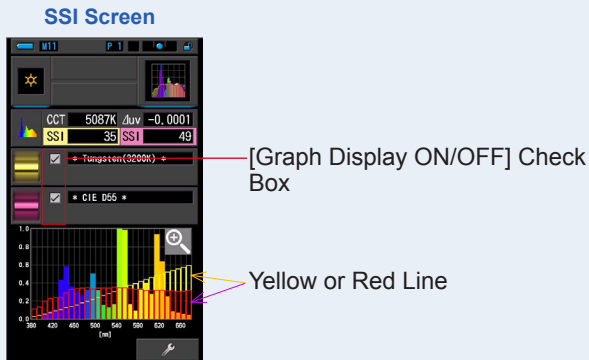

7. Touch the [Magnifying Glass (+)] icon.

The SSI spectrum graph will be enlarged.

The enlarged graph is displayed on the whole screen (landscape).

To return to the SSI screen, touch the [Magnifying Glass (-)] icon on the enlarged SSI spectrum graph.

SSI Screen

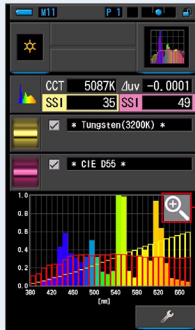

SSI Spectrum Graph Enlarged Display

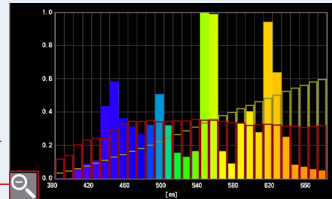

When the enlarged graph is displayed, measurement cannot be performed.

8. Memorize the measurement results.

To record current measurements, press Memory Button  . (➔ P107)

[Color Temperature Input]

Input the color temperature in 100K step from 2500K to 7500K.

1. Touch the [Input Color Temperature] indication on the Select SSI Reference Light screen.

The Input SSI Color Temperature screen will be displayed.

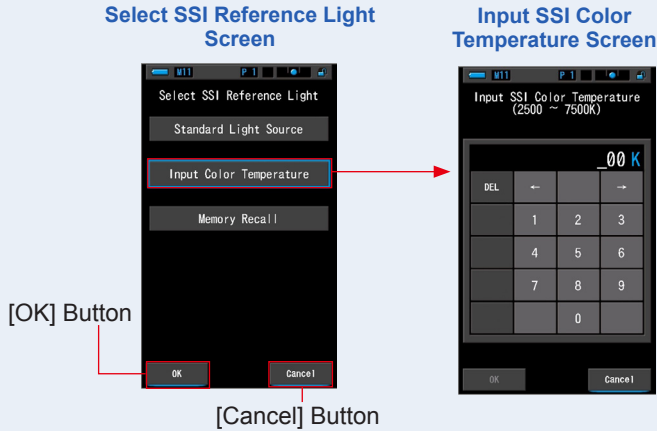

2. Input the desired color temperature to compare.

Input value is displayed in the color temperature display area.

Input SSI Color Temperature Screen

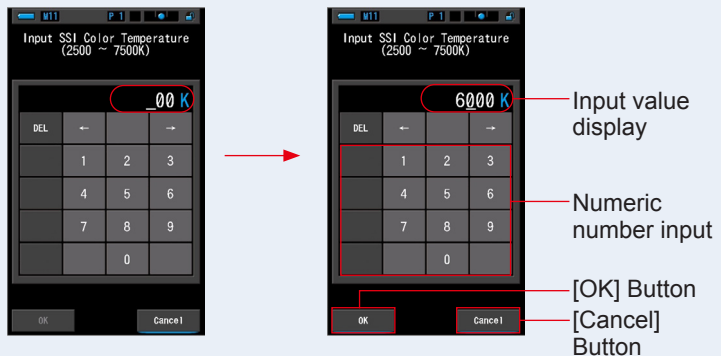

3. Touch the [OK] button.

Confirms the setting and returns to the SSI screen.

To cancel the setting, touch the [Cancel] button.

**NOTE**

Depending on the input color temperature, calculation of light source is different. 2,500K to 4,900K is the color temperature based on the black body radiation. 5,000K to 7,500K is the color temperature based on daylight illuminant.

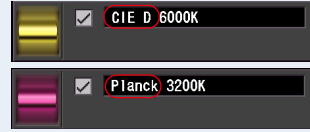
Display Example

4. The input color temperature will be displayed in the reference light source display area on the SSI screen.

You can select up to two reference light sources.

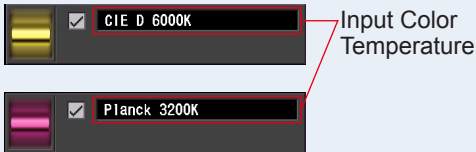
Reference Light Source Display Area

5. SSI value of current measurement to compare with the reference light source will be displayed.

Current Measurement Display Area

6. Yellow and Red line graphs will be displayed in the SSI spectrum graph.

Touch the [Graph Display ON/OFF] check box to hide/show a line graph on the screen.

* shows line. hides line.

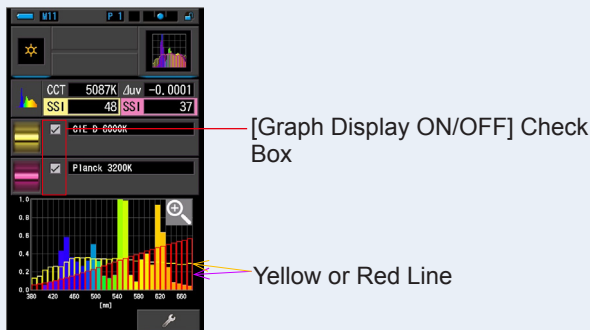
SSI Screen

7. Touch the [Magnifying Glass (+)] icon.

The SSI spectrum graph will be enlarged.

The enlarged graph is displayed on the whole screen (landscape).

To return to the SSI screen, touch the [Magnifying Glass (-)] icon on the enlarged SSI spectrum graph.

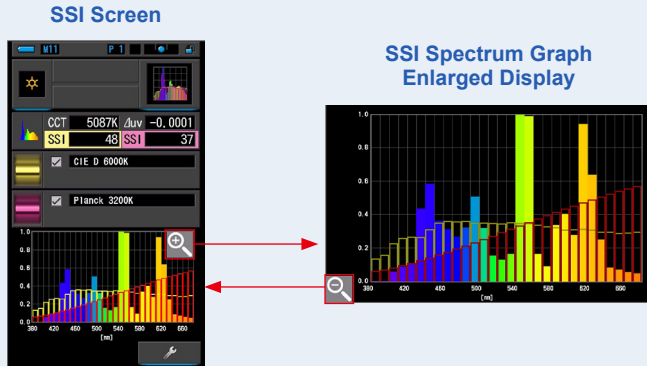

NOTICE

When the enlarged graph is displayed, measurement cannot be performed.

8. Memorize the measurement results.

To record current measurements, press Memory Button  . (→ P107)

[Memory Recall Selection]

You can select the reference light source from memory recall.

Memorize the measurements to be used as reference light source in advance, and compare the current measurement with memorized light source to see the difference in quality.

1. Touch the [Memory Recall] indication on the Select SSI Reference Light screen.

The SSI Memory Recall screen will be displayed.

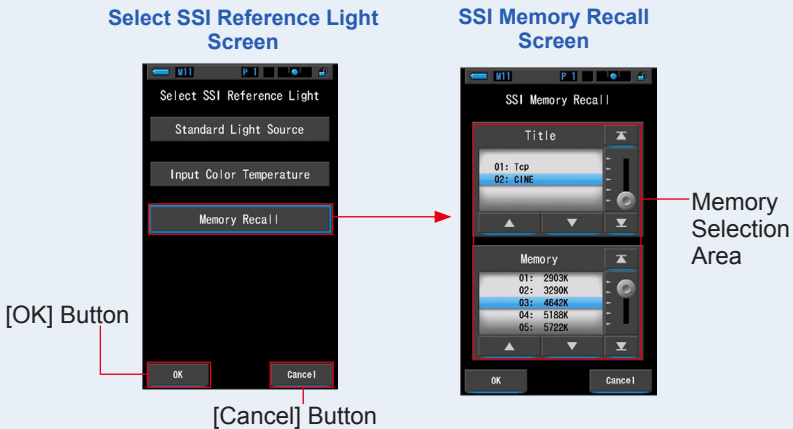

2. Select the desired memory data to compare.

When a title is selected, the memory linked to the title will be displayed.

Select a memorized reading for display and comparison.

To select a title and a memory, match them with the blue background positions.

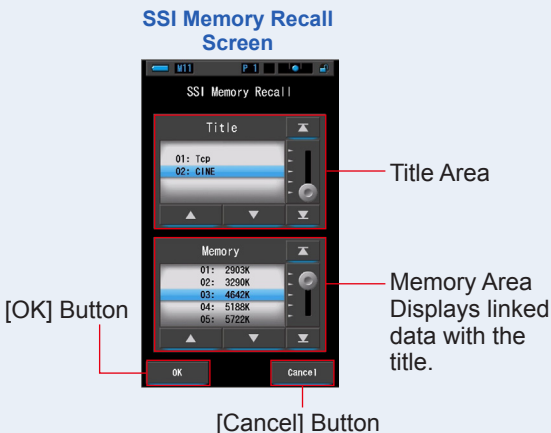

3. Touch the [OK] button.

Confirms the setting and returns to the SSI screen.

To cancel the setting, touch the [Cancel] button.

4. The selected memorized value will be displayed in the reference light source display area on SSI screen.

You can select up to two reference light sources.

Reference Light Source Display Area

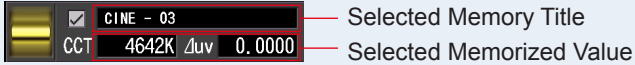

5. SSI value of current measurement to compare with the reference light source will be displayed.

Current Measurement Display Area



6. Yellow and Red line graphs will be displayed in the SSI spectrum graph.

Touch the [Graph Display ON/OFF] check box to hide/show a line graph on the screen.

* shows line. hides line.

SSI Screen

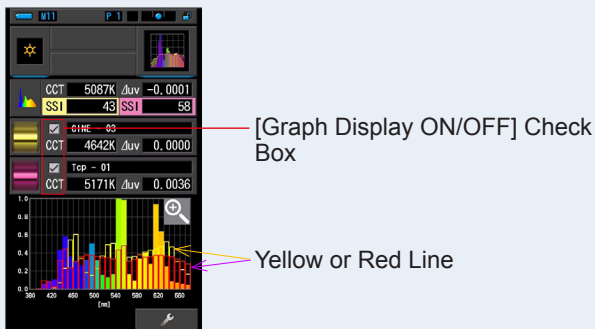

7. Touch the [Magnifying Glass (+)] icon.

The SSI spectrum graph will be enlarged.

The enlarged graph is displayed on the whole screen (landscape).

To return to the SSI screen, touch the [Magnifying Glass (-)] icon on the enlarged SSI spectrum graph.

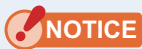
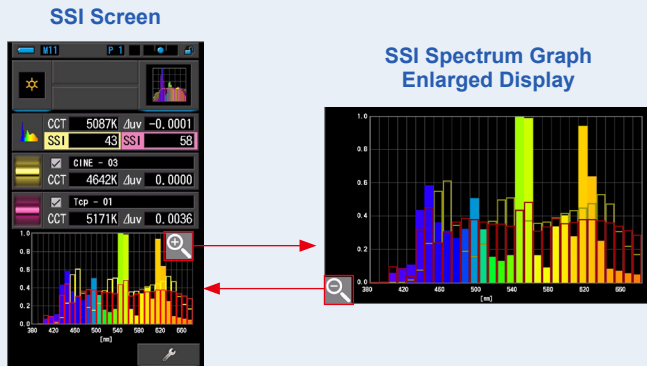

NOTICE

When the enlarged graph is displayed, measurement cannot be performed.

8. Memorize the measurement results.

To record current measurements, press Memory Button **7** . (⇒ P107)

4-4-8 Displaying in TLCI or TLMF [TLCI/TLMF] Mode

Displays the current measurement values and memorized values (in color temperature and Δuv), TLCI and TLMF with spectrum graph. TLCI stands for Television Lighting Consistency Index. TLMF stands for Television Luminaire Matching Factor. (➔ P188)

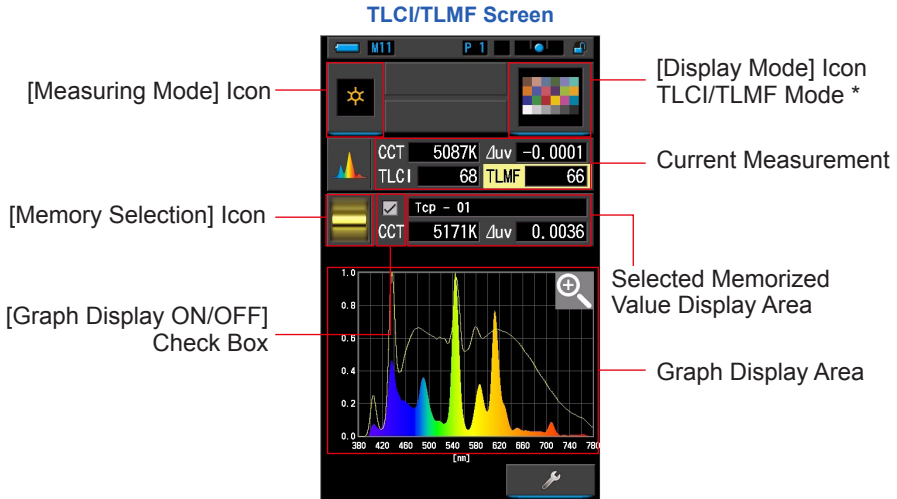

* X-Rite ColorChecker is used for TLCI/TLMF mode icon

Operation

1. Touch the [TLCI/TLMF] icon on the Display Mode Selection screen.



The TLCI/TLMF screen will be displayed. (➔ P30)

2. Touch the [Measuring Mode] icon.

The Measuring Mode Selection screen will be displayed. Select the desired Light Selection Ring ②

3. Press the Measuring Button ⑤ to measure.

The Light Selection Ring ② should be set to L () when taking ambient light measurements.

When measuring flash units, select Range L () or Range H () depending on the brightness of the flash. (➔ P100, ➔ P102)

Measurements are now displayed.

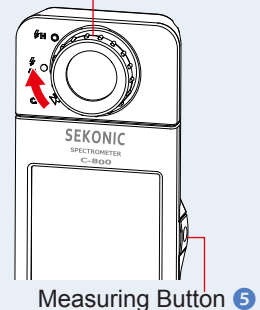



Measurements and display will take longer in light levels below 30lx. The LCD illumination will normally switch off during measurements to avoid influence to measurements.

4. Current measurement appears with the spectrum graph.

5. Touch the [Memory Selection] icon.

The [TLMF Memory Recall] screen will be displayed.

TLCI/TLMF Screen

TLMF Memory Recall Screen

[Memory Selection] Icon

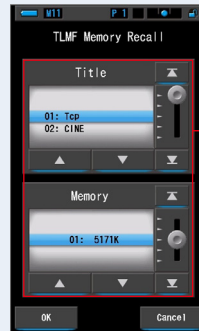
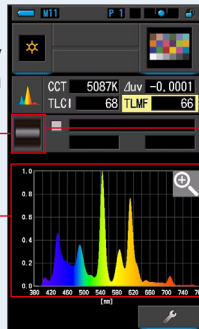

Memory Selection Area

Current measurement in graph

If no measurements have been memorized, the pop-up screen appears to indicate no memorized value.

Memory Selection Pop-up Screen

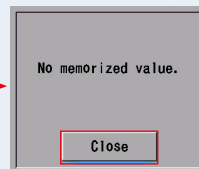
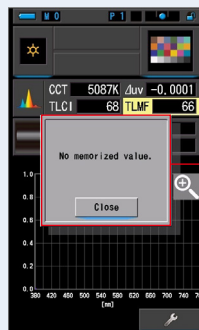

After you confirmed the message "No memorized value.", touch the [Close] button. Returns to the TLCI/TLMF screen.

After memorizing several values, select the memorized value again.

6. Select the desired memorized value to compare.

When a title is selected, the memory linked to the title will be displayed. Select a memorized reading for display and comparison.

To select a title and a memory, match them with the blue background positions.

TLMF Memory Recall Screen

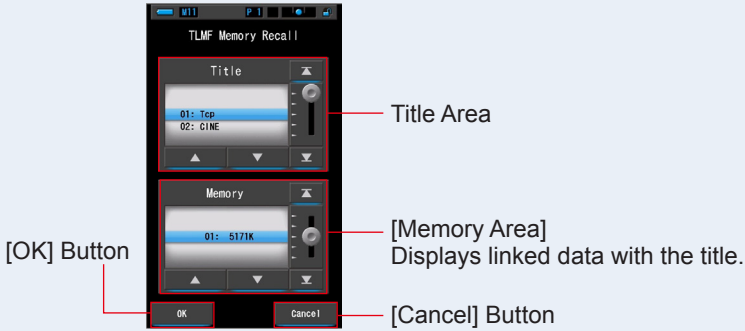

7. Touch the [OK] button.

Confirms the setting and returns to the TLCI/TLMF screen.

To cancel the setting, touch the [Cancel] button.

8. The title of selected memory will be displayed on the TLCI/TLMF screen.

Memory Title Display



9. TLMF index is displayed to compare with the selected memorized value.

Current Measurement Display Area



10. Line graphs will be displayed in the TLCI/TLMF graph.

Touch the [Graph Display ON/OFF] check box to hide/show a line graph on the screen.

* shows line. hides line.

TLCI/TLMF Screen

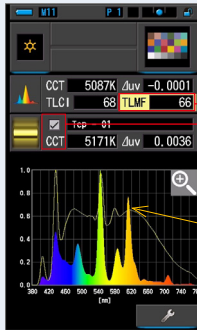

TLMF Index

[Graph Display ON/OFF] Check Box

Graph

11. Touch the [Magnifying Glass (+)] icon.

The spectrum comparison graph will be enlarged.

The enlarged graph is displayed on the whole screen (landscape).

To return to the TLCI/TLMF screen, touch the [Magnifying Glass (-)] icon on the enlarged spectrum comparison graph.

TLCI/TLMF Screen

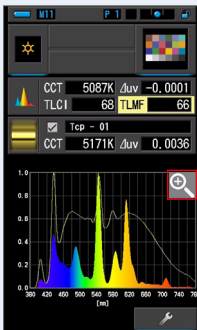

TLCI/TLMF Graph Enlarged Display

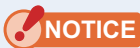
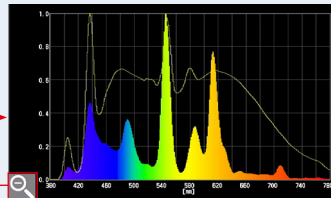

NOTICE

When the enlarged graph is displayed, measurement cannot be performed.

12. Memorize the measurement results.

To record current measurements, press Memory Button . (→ P107)

4-4-9 Displaying in Filter [Filter] Mode

Displays correction values and camera filter names or lighting filter names required to adjust measured light source to target color temperature. You can select either [Lighting Filter] or [Camera Filter].

[Lighting Filter]

Displays correction values and lighting filter names required to adjust measured light source to target color temperature. You can select filter brand on this screen or in Setting screen (LEE, ROSCO E-COLOUR+ or CINEGEL).

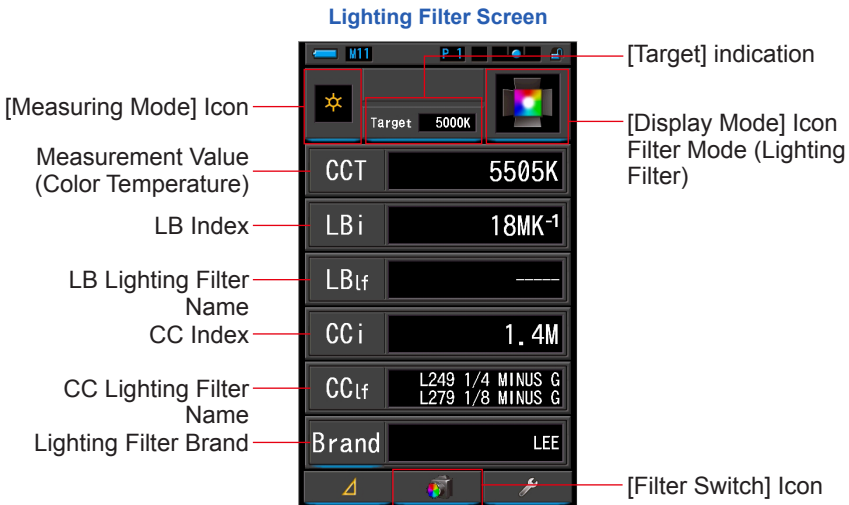

Operation

1. Touch the [Filter] icon on the Display Mode Selection screen. The Lighting Filter or Camera Filter screen will be displayed. (→ P30)

2. Set the Filter mode to use.

The Camera Filter screen and Lighting Filter screen can be switched by toggling the [Filter Switch] icon.

When the current screen shows Camera Filter screen, touch the [Filter Switch] icon to display the Lighting Filter screen.

Camera Filter Screen



Lighting Filter Screen

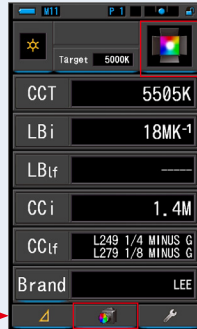

[Filter Switch] Icon

Camera Filter Mode

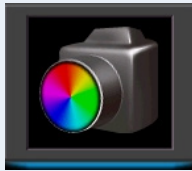

Lighting Filter Mode



3. Touch the [Measuring Mode] icon.

The Measuring Mode Selection screen will be displayed.

Select the desired measuring mode to use. (➔ P22)

4. Touch the [Target] indication.

Target CCT Input screen will be displayed. (➔ P26)

Set the desired color temperature number.

5. Touch the [Brand] indication.

The **Lighting Filter Brand Selection** screen is displayed.

Select the filter brand to use.

Filtration is available in LEE, ROSCO CINEGEL or ROSCO E-COLOUR+.

The meter will display the brand filter number and generic filter value for both LB (CTO, CTB) and CC (Plus / Minus Green).

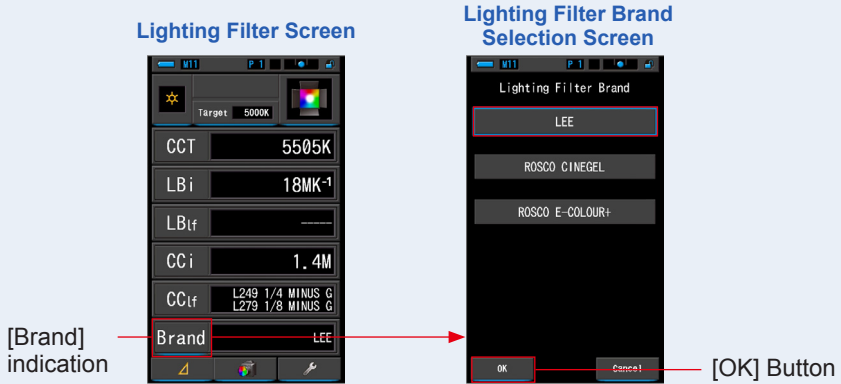

NOTE

The lighting filter brand can also be selected in [Lighting Filter Brand] in [Customize] of [Setting] mode on page 1. (➔ P136)

6. Touch the [OK] button.

Confirms the setting and returns to the Lighting Filter screen.

To cancel the setting, touch the [Cancel] button.

7. Press the Measuring Button ⑤ to measure.

The Light Selection Ring ② should be set to L (⚡) (🔵) when taking ambient light measurements.

When measuring flash units, select Range L (⚡) (🔵) or Range H (⚡H) (🔵) depending on the brightness of the flash. (➔ P100, ➔ P102)

Measurements are now displayed.

Light Selection Ring ②

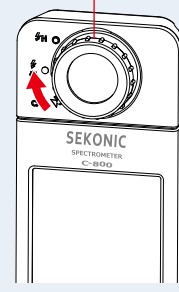

Measuring Button ⑤

**NOTE**

Measurements and display will take longer in light levels below 30lx. The LCD illumination will normally switch off during measurements to avoid influence to measurements.

8. Memorize the measurement results.

To record measurements, press Memory Button  . (→ P107)

**NOTE**

LBi (LB index) is the correction value between target color temperature and actual measured color temperature. CCI (CC index) and CC# (CC filter number) are the values to correct a difference from black body radiation. In the past years when film mode is available (such as C-700, C-500 and other traditional photographic color meters), LBi, CCI or CC# can be correlated with actual lighting filter or camera filter number (LBIf, LBCf, CCIf or CCcf). However, digital mode or industrial spectrometer, LBi, CCI or CC# has no more correlation with actual lighting filter or camera filter number (LBIf, LBCf, CCIf or CCcf). (→ P189)

[Camera Filter]

Displays correction values and camera filter names required to adjust measured light source to target light source.

You can select filter brand on this screen or in Setting screen.
(Kodak WRATTEN 2, FUJIFILM or LEE).

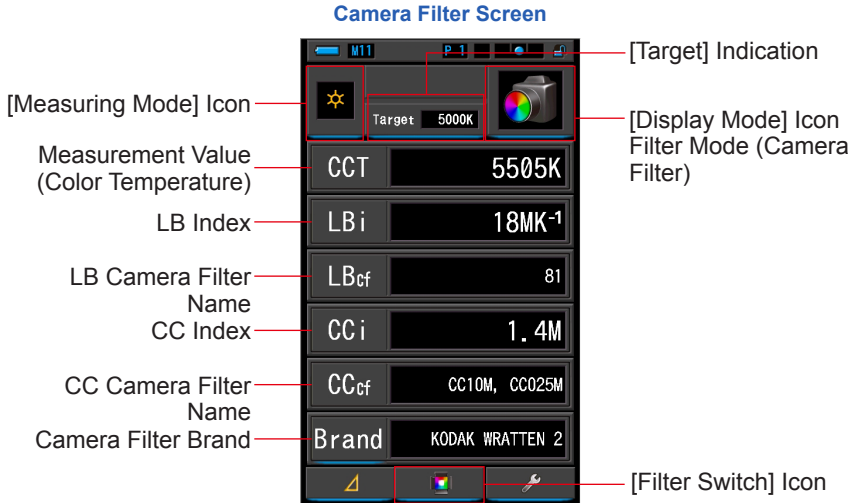

Operation

- 1. Touch the [Filter] icon on the Display Mode Selection screen.**
The Camera Filter or Lighting Filter screen will be displayed. (➔ P30)

2. Set the Filter mode to use.

The Camera Filter screen and Lighting Filter screen can be switched by toggling the [Filter Switch] icon.

When the current screen shows Lighting Filter screen, touch the [Filter Switch] icon to display the Camera Filter screen.

Lighting Filter Screen

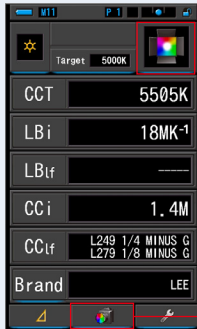

Camera Filter Screen



[Filter Switch] Icon

Lighting Filter Mode

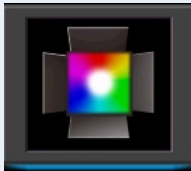

Camera Filter Mode



3. Touch the [Measuring Mode] icon.

The Measuring Mode Selection screen will be displayed.

Select the desired measuring mode to use. (➔ P22)

4. Touch the [Target] indication.

Target CCT Input screen will be displayed. (➔ P26)

Set the desired color temperature number.

5. Touch the [Brand] indication.

The **Camera Filter Brand Selection** screen is displayed.

Select the filter brand to use.

Filtration is available in KODAK WRATTEN 2, FUJIFILM or LEE.

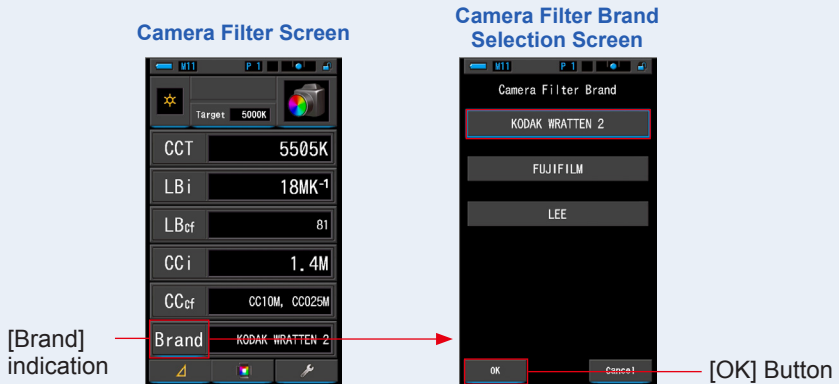

NOTE

The camera filter brand can also be selected in [Camera Filter Brand] in [Customize] of [Setting] mode on page 1. (➔ P132)



6. Touch the [OK] button.

Confirms the setting and returns to the Camera Filter screen.

To cancel the setting, touch the [Cancel] button.

7. Press the Measuring Button ⑤ to measure.

The Light Selection Ring ② should be set to L () when taking ambient light measurements.

When measuring flash units, select Range L () or Range H () depending on the brightness of the flash. (➔ P100, ➔ P102)

Measurements are now displayed.

Light Selection Ring ②

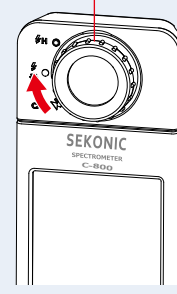

Measuring Button ⑤

**NOTE**

Measurements and display will take longer in light levels below 30lx. The LCD illumination will normally switch off during measurements to avoid influence to measurements.

8. Memorize the measurement results.

To record measurements, press Memory Button  . (➔ P107)

**NOTE**

LBi (LB index) is the correction value between target color temperature and actual measured color temperature. CCi (CC index) and CC# (CC filter number) are the values to correct a difference from black body radiation. In the past years when film mode is available (such as C-700, C-500 and other traditional photographic color meters), LBi, CCi or CC# can be correlated with actual lighting filter or camera filter number (LBIf, LBcf, CCIf or CCcf). However, digital mode or industrial spectrometer, LBi, CCi or CC# has no more correlation with actual lighting filter or camera filter number (LBIf, LBcf, CCIf or CCcf). (➔ P189)

4-4-10 Displaying to Compare Light Sources [Multi Lights] Mode

Displays and compares up to four measurement values on the same screen and displays the correction value from the selected measurement value.

Multi Lights Screen

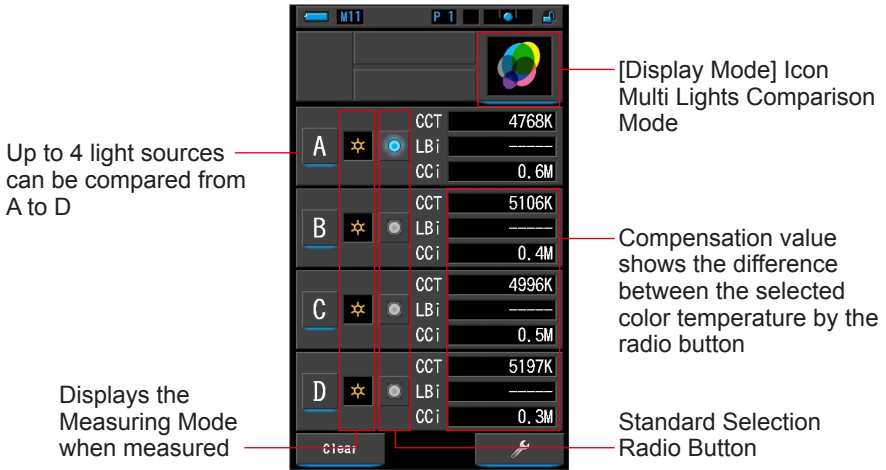

Operation

1. Touch the [Multi Lights] icon on the Display Mode Selection screen.

The Multi Lights screen will be displayed. (→ P30)

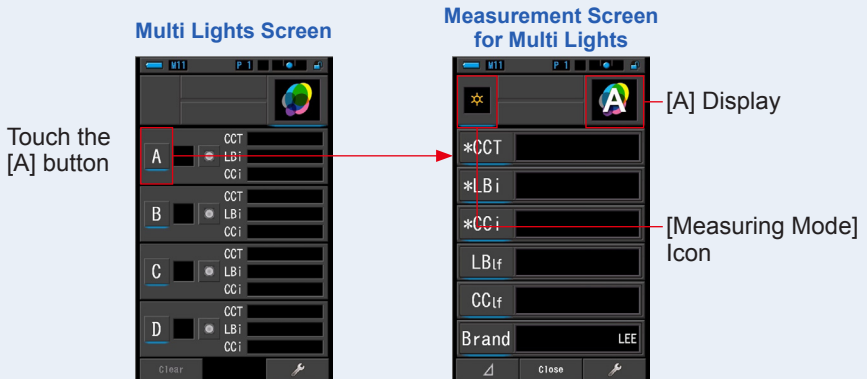

2. Touch the [A] button.

The Measuring screen of [A] will be displayed.



3. Press the Measuring Button ⑤ to measure.

The Light Selection Ring ② should be set to L () when taking ambient light measurements.

When measuring flash units, select Range L () or Range H () depending on the brightness of the flash. (➔ P100, ➔ P102)

Measurements are now displayed.

Light Selection Ring ②



Measuring Button ⑤

Measurement Results Screen for Multi Lights

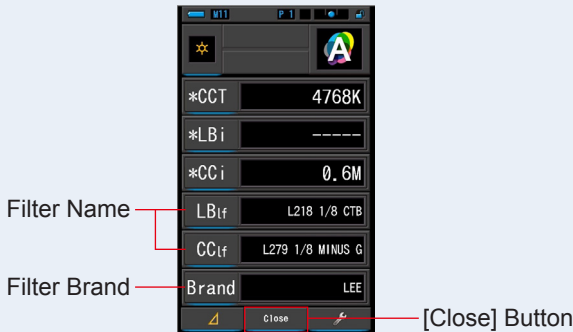

NOTE

- Measurements and display will take longer in light levels below 30lx. The LCD illumination will normally switch off during measurements to avoid influence to measurements.
- When Memory button is pressed while in this Measurement Result Screen in Multi Lights, the value can be stored in memory.

4. Touch the [Display Item] indication to change.

The Display item library screen will be displayed.

The currently selected display item will be encircled in blue.

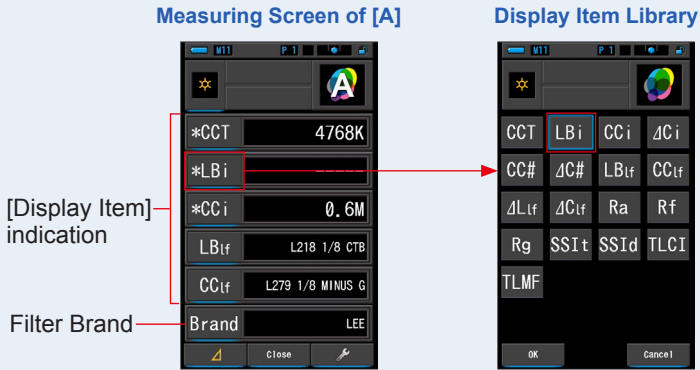

5. Touch the desired Display Item indication and [OK] button.

Confirms the settings, and returns to the Measuring screen. The first three selections marked by * will be displayed on the Multi Lights screen for this and subsequent measurements.

To return to the Measuring screen without changing, touch the [Cancel] button.

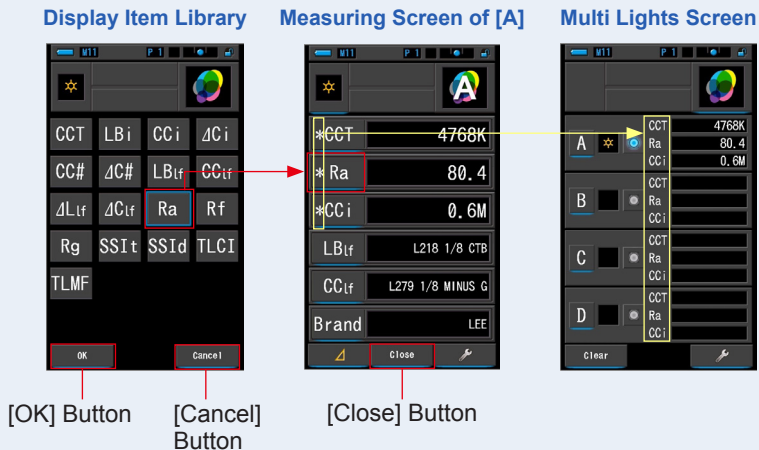

**NOTE**

- CCi** CC index number is to compensate the difference from the black body radiation.
- ΔCi** Δ CC index number is the difference between standard light source and other light sources instead of difference from the black body radiation.
- CC#** CC filter number is the CC correction value from black body radiation in total value of CC filter number.
- ΔC#** Δ CC filter number is the CC correction value in camera filter name from the reference light source CC filter number to measured light source CC filter number. This is useful when the light source selected as standard cannot be filtered to correct (such as fluorescent lamp on the ceiling), and need to match all other light sources to the standard light source in CC filter.
- LBIf** LB lighting filter is the LB correction value in the lighting filter name from the set color temperature (black body).
- CCIf** CC camera filter is the CC correction value in CC camera filter name from black body radiation.
- ΔLIf** Δ LB lighting filter is the LB correction value in LB lighting filter name from the reference light source LB filter number to measured light source LB filter number. This is useful when the light source selected as standard cannot be filtered to correct (such as fluorescent lamp on the ceiling), and need to match all other light sources to the standard light source in LB filter.
- ΔCIf** Δ CC lighting filter is the CC correction value in CC lighting filter name from the reference light source CC filter number to measured light source CC filter number. This is useful when the light source selected as standard cannot be filtered to correct (such as fluorescent lamp on the ceiling), and need to match all other light sources to the standard light source in CC filter.

**NOTE**

LBi (LB index) is the correction value between target color temperature and actual measured color temperature. CCi (CC index) and CC# (CC filter number) are the values to correct a difference from black body radiation. In the past years when film mode is available (such as C-700, C-500 and other traditional photographic color meters), LBi, CCi or CC# can be correlated with actual lighting filter or camera filter number (LBIf, LBcf, CCIf or CCcf). However, digital mode or industrial spectrometer, LBi, CCi or CC# has no more correlation with actual lighting filter or camera filter number (LBIf, LBcf, CCIf or CCcf). (► P189)

6. Touch the [Close] button.

The message "Set the measured value. Are you sure?" will be displayed.

Message Confirmation Screen

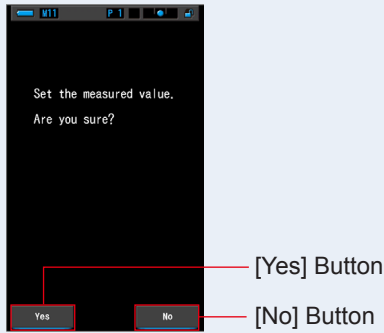

7. Touch the [Yes] button.

Returns to the Multi Lights screen. (Measurement results are reflected in the light source [A])

To return to the Multi Lights screen without reflecting the results, touch the [No] button.

Multi Lights Screen

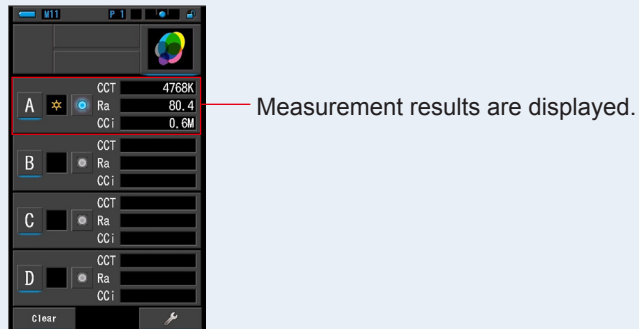

8. Measure other light sources for comparison.

Repeat steps 1 through 7 for display areas B, C and D. Up to 4 light sources can be compared.



NOTE

- Touch the A, B, C or D button to confirm the measured values.
- Measurements and display will take longer in light levels below 30lx. The LCD illumination will normally switch off during measurements to avoid influence to measurements.
- When Memory button is pressed while in this Measurement Result Screen in Multi Lights, the value can be stored in memory.

9. Touch the radio button of the light source to set as the standard.

(●: Selected, ○: Not selected)

Correction value of each other light sources (not selected as standard) are displayed in any value you selected on the Display Item screen.

If LB/CC index or LB/CC Light Filter is selected, the reference value area will display "-----".

Also if any selected indication values in other light sources displays "-----", it means there is little value to correct.

Multi Lights Screen

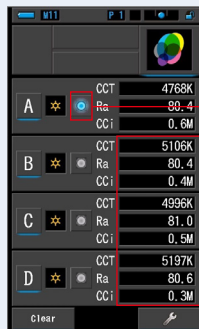

Standard Selection Radio Button Selected Status

Corrected Value Display



To clear all of the measurement results and start a measurement comparison again, touch the [Clear] button.

The Multi Lights Clear Confirmation screen will be displayed.

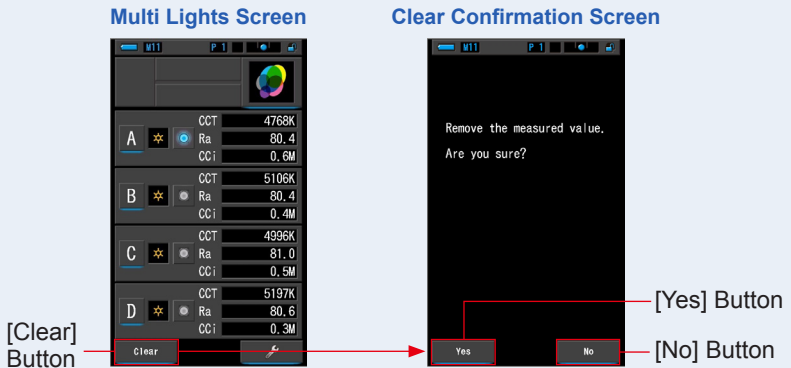

Touch the [Yes] button.

All (A ~ D) will be deleted, and it will return to the Multi Lights screen.

When the [No] button is touched, the display returns to the Multi Lights screen without deleting the values.

4-4-11

Displaying in White Balance Correction Graph [WB Corr.] Mode

Displays the correction values in LB index and CC index between the current measurement value and the target color temperature in a white balance correction graph.

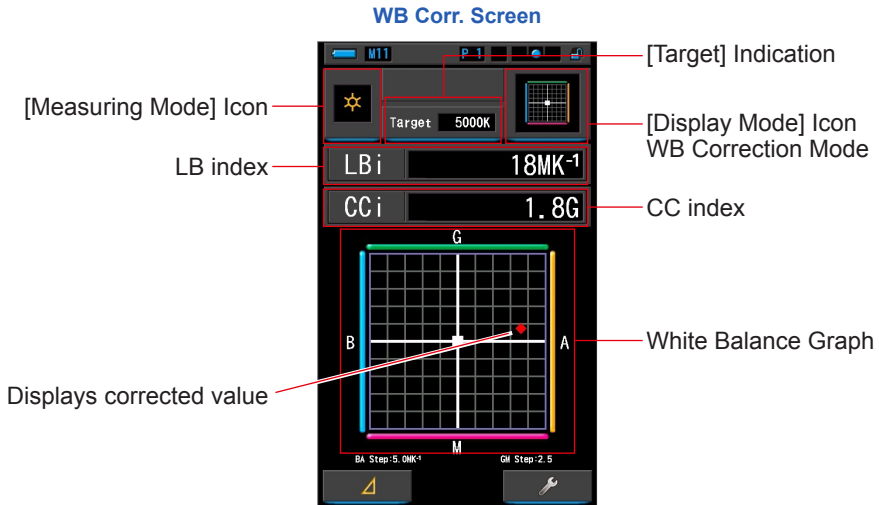

NOTE



The value per grid can be changed in the [White Balance Step] of "Customize" in the Setting screen. Match the value with your camera. (⇒ P138)

Operation

1. Touch the [WB Corr.] icon on the Display Mode Selection screen.
The WB Corr. screen will be displayed. (⇒ P30)
2. Touch the [Measuring Mode] icon.
The Measuring Mode Selection screen will be displayed.
Select the desired measuring mode to use. (⇒ P22)
3. Touch the [Target] indication.
Target CCT Input screen will be displayed. (⇒ P26)
Set the desired color temperature number.

4. Press the Measuring Button 5 to measure.

The Light Selection Ring 2 should be set to L () when taking ambient light measurements.

When measuring flash units, select Range L () or Range H () depending on the brightness of the flash. (→ P100, → P102)

Measurements are now displayed.

Light Selection Ring 2

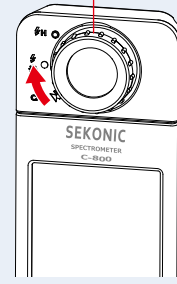

Measuring Button 5



NOTE

Measurements and display will take longer in light levels below 30lx. The LCD illumination will normally switch off during measurements to avoid influence to measurements.

5. The red point shows the correction value from the target color temperature.

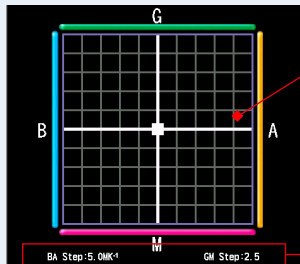

Displays corrected value

Displays value per one grid

6. Memorize the measurement results.

To record measurements, press Memory Button 7 . (→ P107)

4-4-12 Displaying Setting [Setting] Screen

Displays the settings. The contents can be changed according to usage.

For more information about how to set and the details of specifications, see "7-1-1 Item List". (➔ P126)

Setting Screen
Page 1



Setting Screen
Page 2

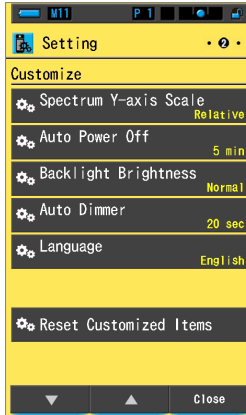

Setting Screen
Page 3

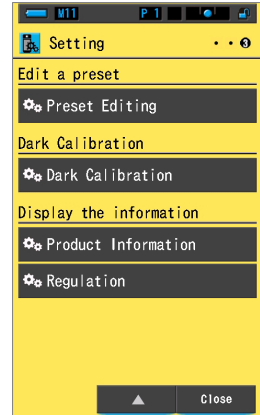

* Models sold in some countries do not display illuminance and exposure in "fc (fc·s)" due to legal restrictions. In this case, Unit of Illuminance is not displayed.



NOTE

Pressing the Menu Button **6** will exit the settings and return to the Display Mode Selection screen.

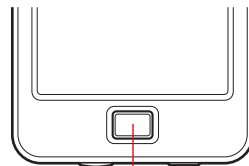

Menu Button **6**

Operation

1. Touch the [Setting] icon on the Display Mode Selection screen.
The Setting screen will be displayed.

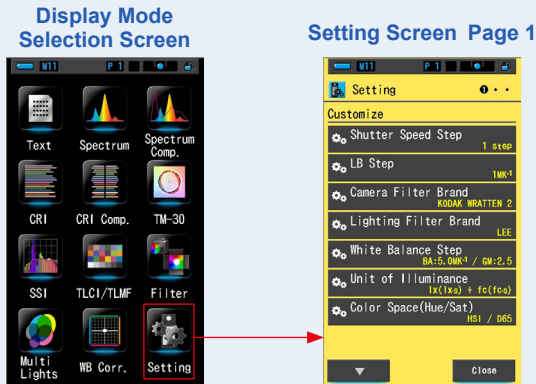

2. Settings show items in white letters and set values in yellow letters.
Touch each item to change the setting.

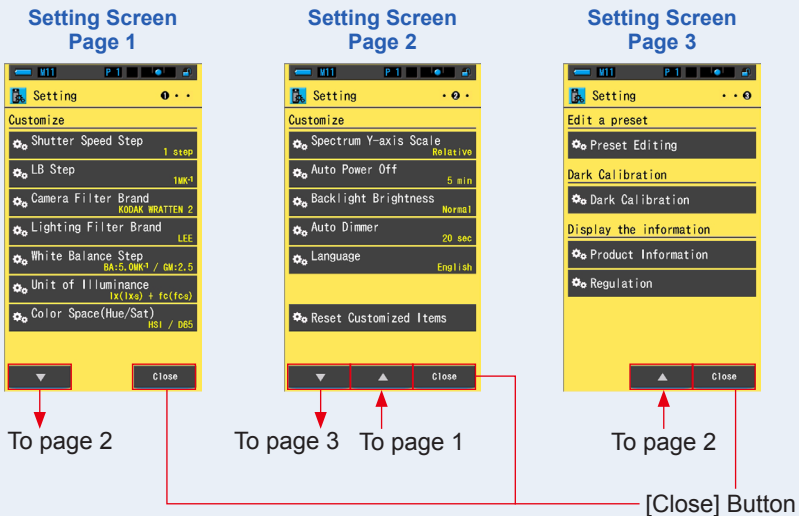

When the [Close] button is touched, the display returns to the Display Mode Selection screen. For more information about how to set and the details of specifications, see "7-1-1 Item List". (➔ P126)

5. Measuring Light Sources [Measurement Screen]

5-1 Measurement Method

5-1-1 Balancing Color Temperatures of Light Sources

When multiple light sources are being used, the color temperature of each light source must be measured separately. If light sources with different color temperatures are used together in the same image, inconsistent color will be present in the shadows and highlights. Take a measurement by facing the Light Receptor ① towards the light source to correctly measure the color temperature of the light source.

Light Receptor ①

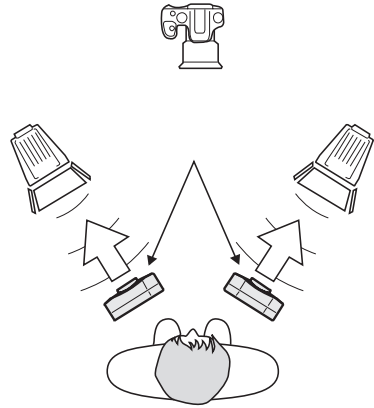
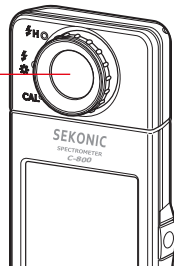

NOTICE

- To get accurate color from a light source, make sure not to get bounced or reflected light from a colored surface, or another light.
- Damage and dirt on the Light Receptor ① can affect the precision of the measurement. If the Light Receptor ① becomes dirty, wipe it with a dry, soft cloth. Never use organic solvents such as thinner or benzene.
- Be courteous to those around you that may be sensitive to flash, or bright light, please give them notice before taking a measurement.

5-2

Measurement in Ambient Light Mode

Select Ambient Light Mode when taking measurements of natural light (sunlight), and continuous light sources such as LED, tungsten lamps and fluorescent lights.

 **WARNING**

Do not look directly into sunlight or other strong light when measuring. It may cause severe eye damage or even loss of vision.

Operation

1. On the Measurement screen, touch the [Measuring Mode] icon and select the [Ambient Light Mode] icon on the Measuring Mode Selection screen.

Select the measuring mode. (⇒ P22)

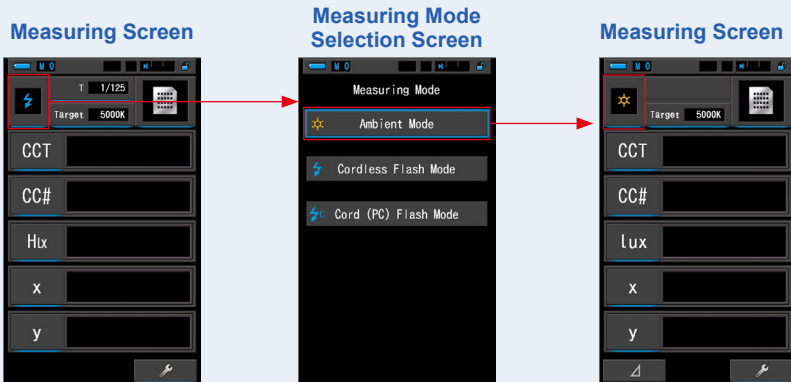

2. Touch the [Target] indication.

Target CCT Input screen will be displayed. (⇒ P26)
Set the color temperature.

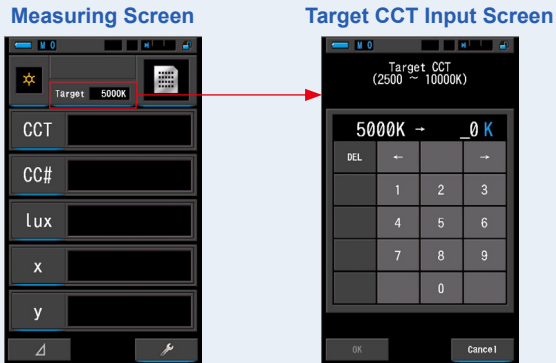

NOTE

If you are not using LB index/filter and CC index/filter values, you can omit this step.

You cannot set the target color temperature in "Spectrum Comp.", "CRI", "CRI Comp.", "SSI", "TLCI/TLMF" and "Multi Lights" Modes.



NOTE

If necessary, you can select a previously created Preset value from Preset Selection in the Tool Box. (⇒ P156)

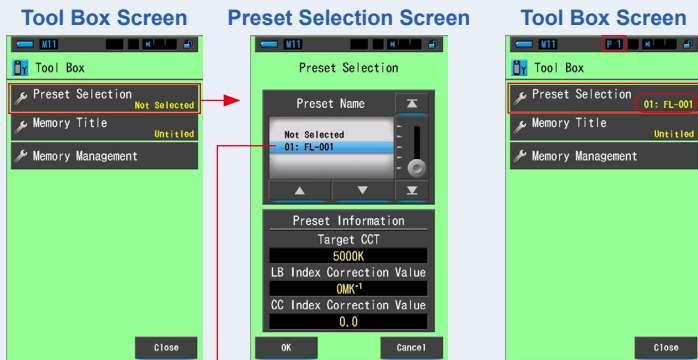



The selected value is indicated by the blue background.

The set content is displayed in yellow letter at the lower right hand corner of the button.

If no presets have been created, the Preset Selection will be grayed out and touching the button will not display the Preset Selection Display.

You can omit this step if unnecessary.

3. Confirm the light measuring range.

When you return to the Measurement screen, make sure to select Range L (  ).

4. Press the Measuring Button .

Measurements are now displayed.

While the button is held, the meter measures continuously.

When the button is released, the measurements will stop and the value at the time of release will be displayed.

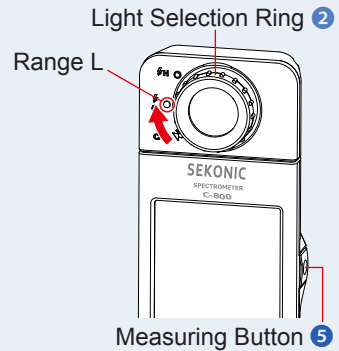

NOTE

- [Over] or [Under] will be displayed if the light source illumination is too bright or not bright enough, or if the color temperature is out of the measurement range, when the Measuring Button is pressed. In this case, adjust the brightness or color temperature of light source.
- Measurements and display will take longer in light levels below 30lx. The LCD illumination will normally switch off during measurements to avoid influence to measurements.

Measurement in Ambient Light Mode is complete.

5-3 Measurement in Cordless Flash Mode

Cordless Flash Mode is preferable when the flash to subject distance is too far to use a sync cord or when wireless measuring is desired. In this measuring mode, the meter will go into measurement standby mode (for 90 seconds) to wait for a burst of flash to measure.

Operation

1. On the Measuring screen, touch the [Measuring Mode] icon and select the [Cordless Flash Mode] icon on the Measuring Mode Selection screen.

Select the measuring mode. (⇒ P22)

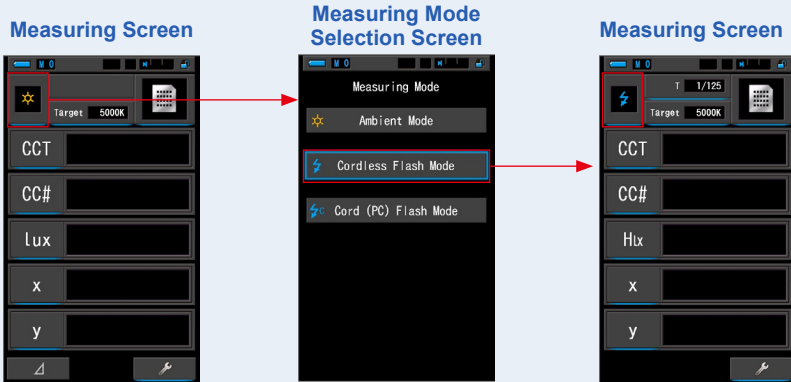

2. Touch the [Target] indication.

Target CCT Input screen will be displayed. (⇒ P26)
Set the color temperature.

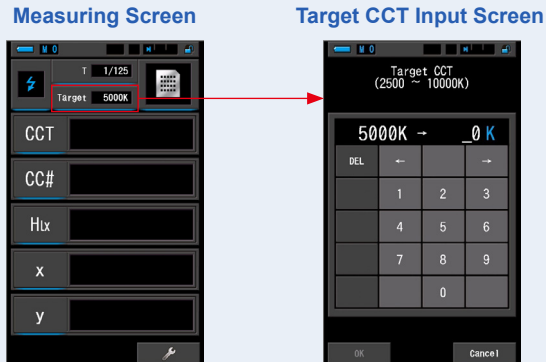

 **NOTE**

If you are not using LB index/filter and CC index/filter values, you can omit this step.

You cannot set the target color temperature in "Spectrum Comp.", "CRI", "CRI Comp.", "SSI", "TLCI/TLMF" and "Multi Lights" Modes.

3. Touch the [T (Shutter Speed)] indication on the Measuring screen.

Set the shutter speed used for measurements. (→ P24)

Match the blue background with the desired shutter speed.

Measuring Screen



[T (Shutter Speed)] Indication



Shutter Speed Selection Screen

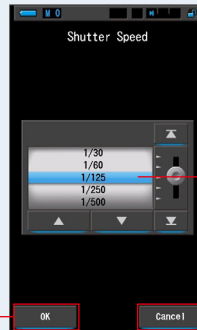

The selected value is indicated by the blue background.

[OK] Button

[Cancel] Button

 **NOTICE**

Select a shutter speed range that will synchronize with your camera and flash system.



4. Confirm the light measuring range.

When you return to the Measurement screen,

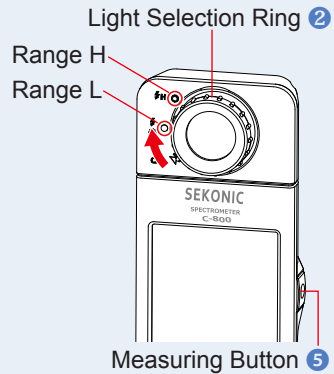
select Range L  or Range H  depending on the brightness of the flash.



NOTE

- Range L : Select when measuring small and low power flash units (lower than 640lx·s), [Over] will appear if flash power is too high. Select Range H.
- Range H : Select when measuring powerful flash units (brighter than 580lx·s), [Under] will appear if flash power is too low. Select Range L.

5. Press the Measuring Button .

The meter will enter measurement standby mode.

While the icon is blinking, manually trigger the flash.

The [Measuring Mode] icon will blink for 90 seconds when measuring.

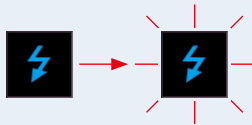

The display illumination will dim when the measuring button is pressed as the display illumination can affect the reading. This is normal.

When the flash light is fired, the measured value will be displayed for 3 seconds, and the display will return to measurement standby mode.

To cancel standby mode, touch the screen or press the Menu Button .



NOTE

When the icon stops blinking before triggering the flash, or when you want to take measurements again, press Measuring Button  again.

Measurement in Cordless Flash Mode is complete.



CAUTION

- Do not trigger flash while skin or other objects are in contact with the flash tube. Do not touch the flash tube after repeated flashes. (It may cause burns.)
- Do not trigger flash while near the eyes of people or animals. (It may temporarily affect vision.)
- The flash may be triggered suddenly. Because there is the possibility of burns or negative effects on vision, please handle with care.



NOTICE

- When using Cordless Flash Mode, the LCD screen backlight dims during measurement, and the LCD backlight is illuminated for only 3 seconds after measurement. To cancel standby mode, touch the screen or press the Menu Button **6** .
- In case of the following, please follow "5-4 Measurement in Cord (PC) Flash Mode" (➔ P93)
 - If the flash output power is too weak compared to the surrounding light, the meter may not detect the flash output.
 - Pulsed light sources such as fluorescent lights or special lighting could cause the meter to take cordless flash measurements in rare cases.
 - If the Light Receptor **1** detects a sudden and bright change in lighting intensity, the meter may mistakenly take a measurement.
 - Because the light radiated from a flash bulb gradually builds, the meter will not detect the light when used in Cordless Flash Mode.



NOTE

- When using the meter in Cordless Flash Mode, it is possible to mount the meter to a light stand, tripod or similar support using the Tripod Socket **10** .
- [Over] or [Under] will be displayed if the light source illumination is too bright or not bright enough, or if the color temperature is out of the measurement range, when the Measuring Button is pressed. In this case, adjust the brightness or color temperature of light source, or switch the light range. (➔ P100)

5-4 Measurement in Cord (PC) Flash Mode

Cord (PC) Flash Mode is preferable when lighting conditions prevent the use of cordless measurements or when certain types of equipment require a physical sync connection.

In Cord (PC) Flash Mode, the meter and flash unit are connected with a Sync Cord (sold separately).

CAUTION

- Do not handle this product with wet hands, or leave it in the rain or in a location where it may be splashed with water, submerged, or come into contact with moisture. There is a danger of electric shock in Cord (PC) Flash Mode. This may also result in damage to the product.
- When using flash with high voltage, there is a danger of electric shock if you touch the Sync Terminal . Handle the flash with care when using for measurement.

Operation

1. On the Measuring screen, touch the [Measuring Mode] icon and select the [Cord (PC) Flash Mode] icon on the Measuring Mode Selection screen.

Select the measuring mode. (→ P22)

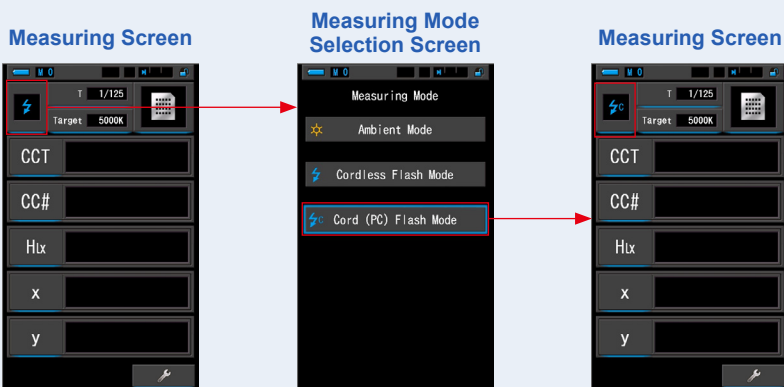

2. Touch the [Target] indication.

Target CCT Input screen will be displayed. (⇒ P26)
Set the color temperature.

Measuring Screen

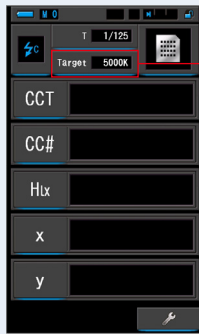

Target CCT Input Screen



NOTE

- If you are not using LB index/filter and CC index/filter values, you can omit this step.
- You cannot set the target color temperature in "Spectrum Comp.", "CRI", "CRI Comp.", "SSI", "TLCI/TLMF" and "Multi Lights" Modes.

3. Connect the sync cord (sold separately) to the Sync Terminal 12 of the meter.

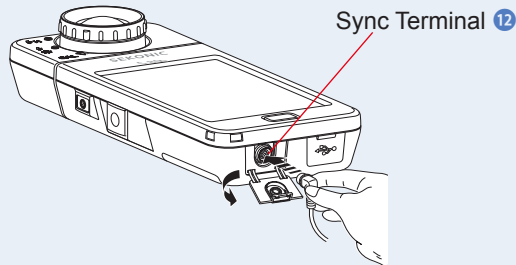

CAUTION

Depending on the flash equipment used, the flash may be triggered when the sync cord is connected to the Sync Terminal 12 or when operating the Power Button 3. Because there is the possibility of burns or negative effects on vision, please handle with care.

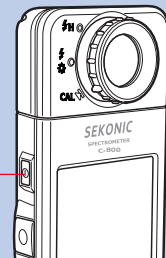

Power Button 3

4. Touch the [T (Shutter Speed)] indication on the Measuring screen.

Set the shutter speed used for measurements. (→ P24)

Match the blue background with the desired shutter speed.

Measuring Screen

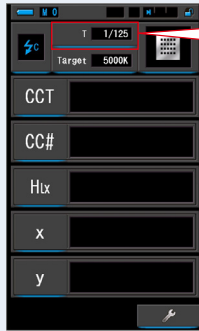

[T (Shutter Speed)] Indication



Shutter Speed Selection Screen

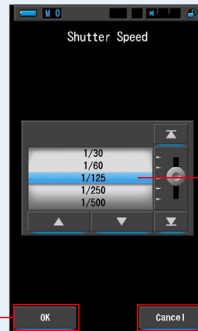

The selected value is indicated by the blue background.

[OK] Button

[Cancel] Button





NOTICE

Select a shutter speed that will synchronize with your camera and flash system.



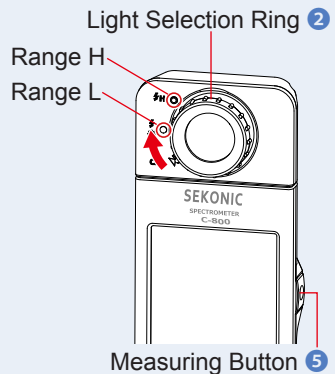

5. Confirm the light measuring range.

When you return to the Measurement screen,

select Range L  or Range H  depending on the brightness of the flash.



**NOTE**

- Range L  (): Select this when measuring small and low power flash units (lower than 640lx·s), [Over] will appear if flash power is too high. Select Range H.
- Range H  (): Select when measuring powerful flash units (brighter than 580lx·s), [Under] will appear if flash power is too low. Select Range L.

6. Press the Measuring Button .

Measurement will be taken with flash, and the light source values will be displayed.

Because it affects measurement while measuring, the LCD backlight will dim. It is not a defect.

Measurement in Cord (PC) Flash Mode is complete.



CAUTION

- Depending on the flash equipment used, the flash may be triggered when the sync cord is connected to the Sync Terminal ⑫ or when operating the Power Button ③ . Because there is the possibility of burns or negative effects on vision, please handle with care.
- Do not trigger flash while skin or other objects are in contact with the flash tube. Do not touch the flash tube after continuous flashes. (It may cause burns.)
- Do not trigger flash while near the eyes of people or animals. (It may temporarily affect vision.)
- The flash may be triggered suddenly. Because there is the possibility of burns or negative effects on vision, please handle with care.



NOTICE

- If the triggering voltage of the flash used is extremely low, the flash may not trigger. In this case, use "5-3 Measurement in Cordless Flash Mode". (➔ P89)
- When measuring flash bulbs, make sure the shutter sync speed is set to the proper synchronization range of your camera.



NOTE

[Over] or [Under] will be displayed if the light source illumination is too bright or not bright enough, or if the color temperature is out of the measurement range, when the Measuring Button is pressed.

In this case, adjust the brightness or color temperature of light source, or switch the light range. (➔ P100)

5-5

Comparison Function (in Ambient Light Mode only)

Comparison Function is available in the following Display Modes with all Display Items (except LB, CC filter name). Text, Spectrum, CRI, TM-30, Filter and WB Corr..

When you touch the [Delta] icon () , the [Delta] icon changes to () .

While this mode, the difference between standard value and currently being measured value is displayed as long as the Measuring Button  is pressed.

The reference value is the measurement value when the [Delta] icon is pressed.

When the Measuring Button  is released, the standard value is displayed as the last measurement.

The graphs in Spectrum, CRI, TM-30, and White Balance Correction modes show the standard value only even if Comparison Function is activated.

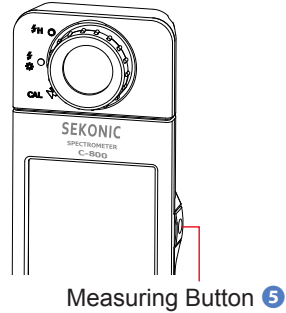

Operation

1. Press the Measuring Button  and start measurements.

The measurement results will be displayed.

Measuring Screen



NOTE

Measurements and display will take longer in light levels below 30lx. The LCD illumination will normally switch off during measurements to avoid influence to measurements.

2. Touch the [Delta] () icon.

The measurement results right before touching the icon will become the standard values.

The [Delta] icon will change to ().

Measuring Screen

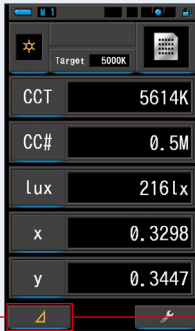

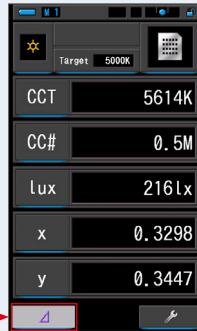

Measuring Screen



[Delta] Icon

3. Hold the Measuring Button .

While the [Delta] icon is activated (), the difference with the standard value is displayed as long as the Measuring Button  is pressed.

Measuring Screen

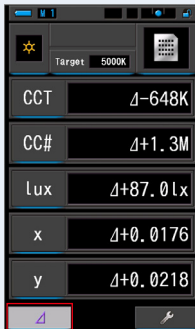

4. Comparison Function is complete.



When the Measuring Button  is released, the standard value is displayed.

5. Touch the [Delta] () icon.

The [Delta] icon will be deactivated ().



NOTE

- If the [Delta] icon shows  , take a measurement first to activate Comparison function.
- The [Delta] icon () is deactivated when the power is turned OFF.
- When the [Delta] icon is displayed, the Memory Button  is disabled.

5-6

When [Over], [Under], [Filter N/A] or red letter is Displayed

When [Over] or [Under] is displayed, measurement cannot be taken.

When [Filter N/A] is displayed, the indicated value is out of display range, but measurement can still be taken.



5-6-1

Display of [Over], [Under], [Filter N/A] or red letter

When [Over] is displayed:

If the indicated values are higher than the maximum measuring range, [Over] is displayed.



When measuring ambient light, decrease the brightness of the illumination.

When measuring flash light, turn the Light Selection Ring ②, and change the range from L ⚡ () to H ⚡H (), or lower the flash output power. ⚙️

When [Under] is displayed:

If the indicated values are lower than the minimum measuring range, [Under] is displayed.

When measuring ambient light, increase the brightness of the illumination.

When measuring flash light, turn the Light Selection Ring ②, and change the range from H ⚡H () to L ⚡ (), or raise the flash output power. ⚙️

When [Filter N/A] is displayed:

If [Filter N/A] appears in the filter number indication, it is out of display range (combination) of filter number.

Take a new measurement after changing the target color temperature.

When the value of Hue is displayed in red letter:

When using the Hue & Saturation function, it is possible for the hue value to turn from white text to red text. This is an indication that the saturation of the light measured is too low for an accurate hue measurement. You will find this if a light has a saturation below 30%.

Light Selection Ring ②

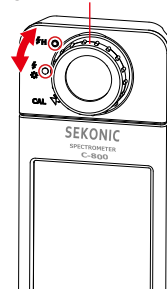

Measuring Button ⑤



Measurements and display will take longer in light levels below 30lx. The LCD illumination will normally switch off during measurements to avoid influence to measurements.

**Display range:**

Color Temperature : 1,600K ~ 40,000K
 LB Index : -500 to +500MK⁻¹

LB Filter Numbers**Camera Filter**

Kodak WRATTEN 2/LEE : 80A+80B to 85B+85
 FUJIFILM LBA/LBB : LBB-20 + LBB-16 to LBA-20 + LBA-16

Lighting Filter

LEE : L287 DOUBLE CTO + L204 FULL CTO to L200
 DOUBLE CTB + L283 1.5 CTB
 ROSCO CINEGEL : R3420 DOUBLE CTO + R3407 FULL CTO to R3220
 DOUBLE CTB + R3202 FULL CTB
 ROSCO E-COLOUR+ : E287 DOUBLE CTO + E204 FULL CTO to E200
 DOUBLE CTB + E283 1.5 CTB

CC Index : 80G to 80M

CC Filter Numbers : 200G to 200M

Camera Filter

Kodak WRATTEN 2/LEE : CC50M + CC40M to CC50G + CC40G
 FUJIFILM CC : CC-50M + CC-40M to CC-50G + CC-40G

Lighting Filter

LEE : L247 MINUS GREEN + L248 1/2 MINUS GREEN to
 L244 PLUS GREEN + L245 1/2 PLUS GREEN
 ROSCO CINEGEL : R3308 MINUS GREEN + R3309 3/4 MINUS GREEN to
 R3304 PLUS GREEN + R3315 1/2 PLUS GREEN
 ROSCO E-COLOUR+ : E247 MINUS GREEN + E248 1/2 MINUS GREEN to
 E244 PLUS GREEN + E245 1/2 PLUS GREEN

Illuminance lux : 1lx to 200,000lx





Exposure lux-second : 20lx·s to 20,500lx·s

Illuminance foot-candle : 0.1fc to 18,600fc

Exposure foot-candle-second : 1.86fc·s to 1,900fc·s

5-6-2 Changing the Light Range

Change and use the light range depending on the brightness of the flash.

Light Selection Ring (Status Bar Display)			Content
Dark Calibration Position		CAL	Select for dark calibration only. Measurement cannot be made in this position.
Range L			Select for ALL ambient light measurement, and low power flash units (lower than 640lx·s/59.5fc·s)
Range H			Select for powerful flash units (brighter than 580lx·s/53.9fc·s) only.

Turn the Light Selection Ring ② and select the desired range.
The set range will be displayed on the LCD screen's status bar.

Status Bar

RANGE L



RANGE H

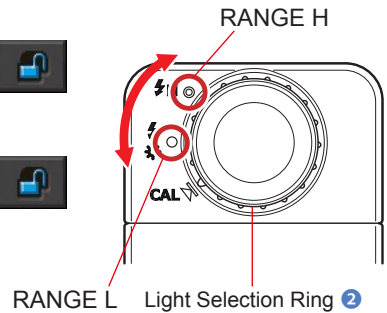

6. Measurement Tool [Tool Box] Screen

Selecting Screens from the Tool Box

Touch the [Tool Box ()] icon in the Measuring screen to display the Tool Box screen. (⇒ P15) You can select screens from the Tool Box as follows.



6-1 Setting Preset Contents [Preset Selection] Screen

Presets are a quick way to introduce adjustments to the camera/light source filter recommendations.

You can create and store Presets for different lighting conditions or color effects to use when ever needed. (➔ P156)

Also, when you use several target color temperatures, setting them in "Edit a Preset" beforehand makes it easier to change target color temperatures by recalling one of presents in Tool Box even if you do not input a target color temperature every time.

Preset Selection Screen

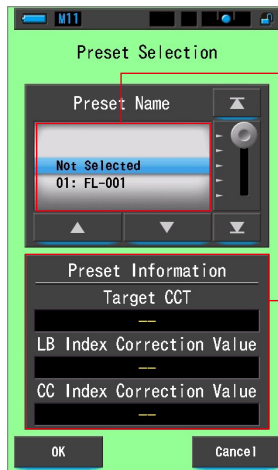

Presets which are set to "Displayed" in the "Preset Editing" in "Setting" screen appears here.

Contents of selected Preset is displayed,

Operation

1. Touch the [Preset Selection] button in the Tool Box.

The Preset Selection screen will be displayed.



NOTICE

A Preset value must be created and set to “Displayed” in the Preset Editing function under the “Setting Mode” icon before it can be used.
(→ P156)

Preset Selection buttons will be grayed out until settings are created and set to “Displayed”.

2. Select desired preset no. (01 ~ 19).

Touch Up/Down buttons or move slide to position the desired Preset under the blue bar.

Preset Selection Screen

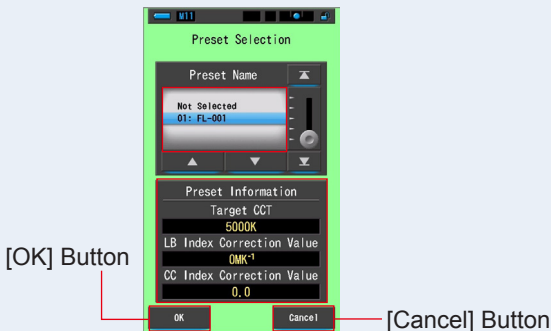

NOTICE

Be sure to set Preset Selection to “Not Selected” when no correction is desired.

3. Touch the [OK] button.

Confirm and return to the Measuring screen.

To cancel the setting, touch the [Cancel] button.

The selected status will be displayed on the status bar.

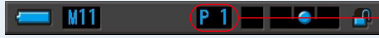

The selected preset no. is displayed.

The preset is set.



When selected, the Preset Color Temperature is used by the meter in place of the Target Color Temperature that was selected from the Measuring screen.

6-2 Using the Memory Function

The memory function enables storing light source data for single sources and groups of sources for recall at any time. Up to 99 measurements can be stored. Memory function also enables naming or renaming the title of memory and clearing the stored value.

Memory Management Screen



Tool Box Screen

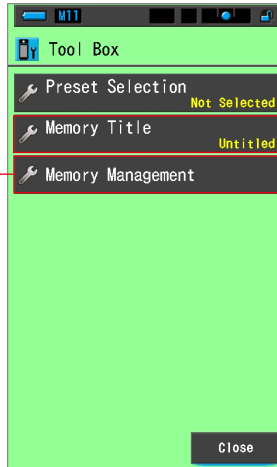

Memory Title Screen

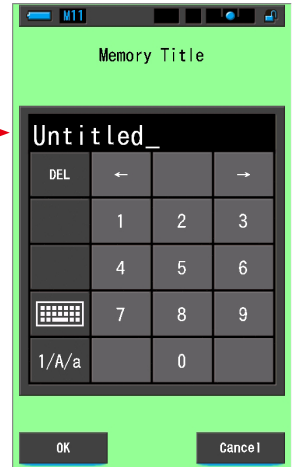

Memory Recall Screen



Memory Edit Screen

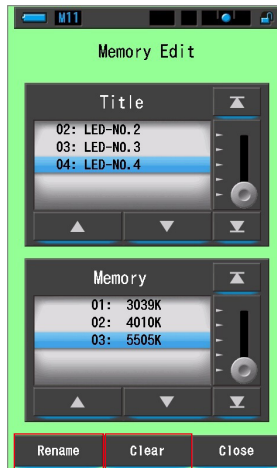

Renaming Memory Title

Clearing Memorized Value

6-2-1

Naming Measurement Being Memorized [Memory Title] Screen

You can create special titles for memorized values to make them easier to select, view and use data later.

To use this function the order of operation:

- Create memory title
- Measure light source
- Press Memory button  to memorize

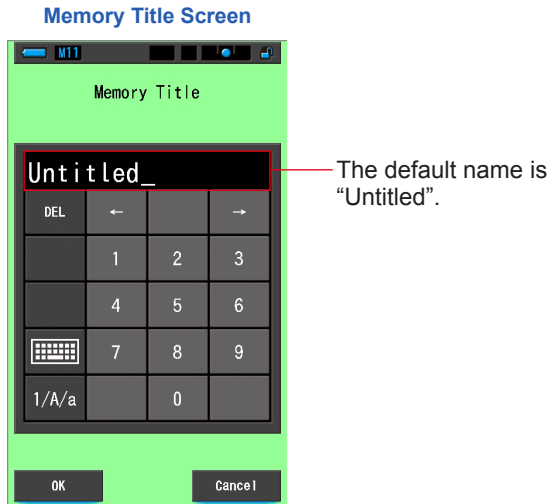

NOTE

- A title can be a maximum of 16 alphanumeric characters.
- More than one measurement can be stored under one title.
- Up to 99 titles can be created.

Operation

1. Touch and select the [Memory Title] button in the Tool Box.
The Memory Title screen will be displayed.



2. Enter the memory title. (→ P18)

Use the keyboard to create a name for the measured light.

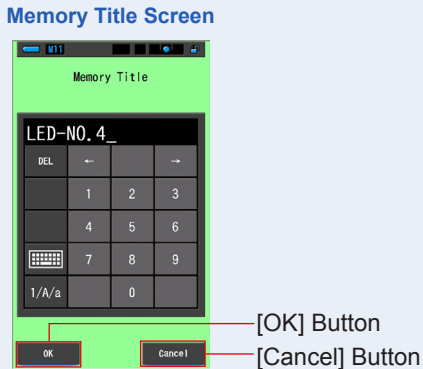

3. Touch the [OK] button.

Confirm and return to the Measuring screen.

To cancel the setting, touch the [Cancel] button.

The memory title is entered.





The memory title needs to be entered before memorizing.
The title can be changed after memorizing in Memory Management function. (→ P116)

4. Measure light.

Press Measuring Button 5 to take a measurement.

The Light Selection Ring 2 should be set to L () when taking ambient light measurements.

When measuring flash units, select Range L () or Range H () depending on the brightness of the flash. (⇒ P100, ⇒ P102)

Light Selection Ring 2

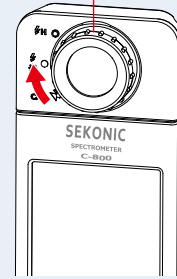

Measuring Button 5

Measuring Screen

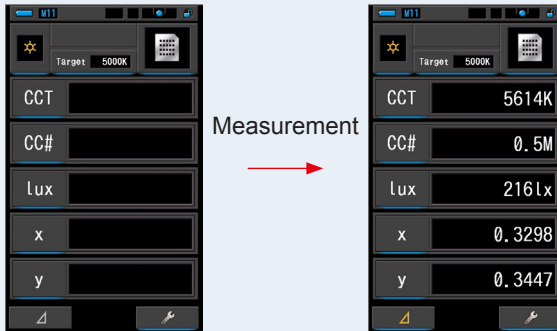

5. Press Memory Button 7 to memorize light source values and link the reading to the created title name.



Memory Button 7

6-2-2 Recalling Measurement Results [Memory Recall] Screen

The Memory Recall screen enables selecting a specific Title and Memory number to view and inspect values stored in the memory under any Display Mode.

Ex.) Memory Recall Spectrum Screen

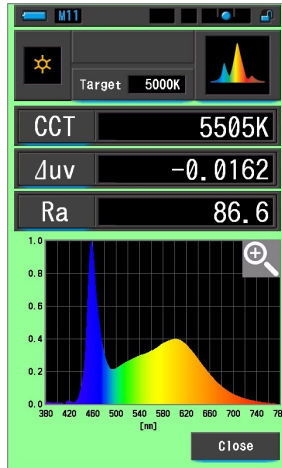

Operation

1. Touch the [Memory Management] button in the Tool Box.
Memory Management screen will be displayed.
2. Select the "Title" and "Memory" to recall with the blue background positions.

Tool Box Screen

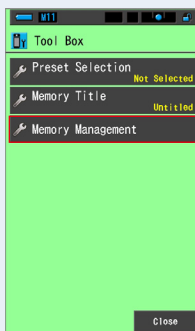

Memory Management Screen

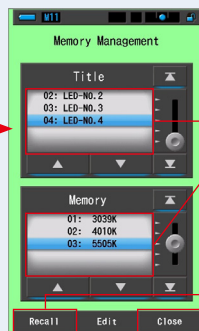

Move Title and then Memory number into the blue background to make a selection.

[Recall] Button

[Close] Button

3. Touch the [Recall] button.

The meter will display the display mode viewed when the light source was measured.

To cancel the setting, touch the [Cancel] button.

4. Confirm the memory contents.

Display Mode at the time when measured appears.

In Memory Recall Mode, the background color becomes green.

Memory Title of recalled value appears every two seconds on the status bar.

Ex.)

Memory Recall Mode Spectrum Screen

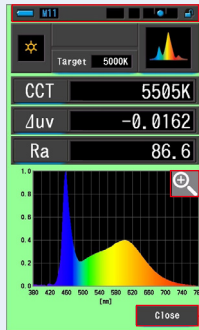

Spectrum Distribution Graph Enlarged Display

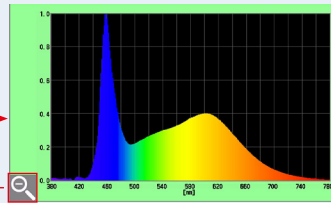

[Close] Button

NOTICE

- Only the current reading can be memorized in the [Spectrum Comparison] Mode. If the Spectrum Comparison screen is displayed when the memory button is pressed, the stored data will be displayed on the Spectrum display screen.
- In Memory Recall Mode, measurement cannot be made.

5. Touch the [Close] button.

Returns to the Measuring screen.

Changing Memory Recall Mode Display

Touch one of the [Display Mode] icons in Memory Recall Mode, and the specified display with memorized data for that Memory Recall Mode will appear.

Memory Recall Mode Display Mode Selection Screen

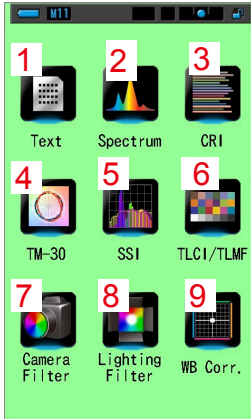

1 Memory Recall Mode Text Mode



2 Memory Recall Mode Spectrum Mode

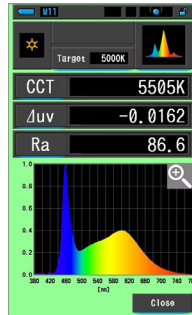

3 Memory Recall Mode CRI Mode

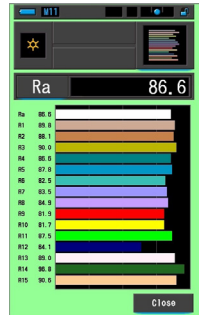

4 Memory Recall Mode TM-30 Mode

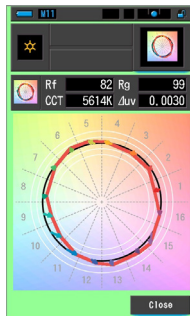

5 Memory Recall Mode SSI Mode

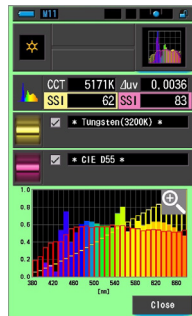

6 Memory Recall Mode TLCI/TLMF Mode

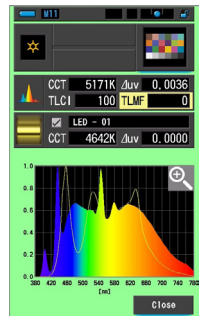

7 Memory Recall Mode Camera Filter Mode





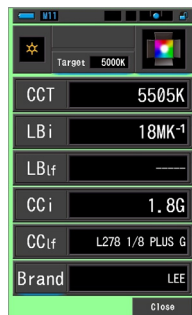



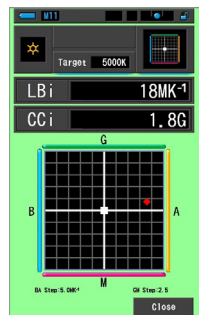

8 Memory Recall Mode Lighting Filter Mode



9 Memory Recall Mode WB Corr. Mode

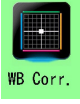

No.	Display Mode Icon	Part Name	Description
1	 Text	Memory Recall Mode [Text] Icon	Displays user-selected 5 items in numeric values. (➔ P34)
2	 Spectrum	Memory Recall Mode [Spectrum] Icon	Displays 3 user-selected values and spectrum distribution graph. (➔ P37)
3	 CRI	Memory Recall Mode [CRI] Icon	Displays the selected average CRI (Ra) or individual CRI (R1 ~ R15) numerically. Each CRI is displayed in a graph. (➔ P43)
4	 TM-30	Memory Recall Mode [TM-30] Icon	Displays four current measurement values (Rf, Rg, CCT, Δuv) and color vector graphic. (➔ P49)
5	 SSI	Memory Recall Mode [SSI] Icon	Compares the current measurement value and up to 2 reference values (color temperature and Δuv), and displays SSI index with the SSI spectrum graph. (➔ P51)
6	 TLCI/TLMF	Memory Recall Mode [TLCI/TLMF] Icon	Displays the current measurement values and memorized values (in color temperature and Δuv), TLCI and TLMF with spectrum graph. (➔ P62)
7	 Camera Filter	Memory Recall Mode [Camera Filter] Icon	Displays correction values and camera filter names required to adjust measured source to Target Color temperature. (➔ P70)
8	 Lighting Filter	Memory Recall Mode [Lighting Filter] Icon	Displays correction values and lighting filter names required to adjust measured source to Target Color temperature. (➔ P66)
9	 WB Corr.	Memory Recall Mode [WB Corr.] Icon	Displays correction values in LB index and CC index between the current measurement value and the target color temperature in a white balance graph. (➔ P81)



NOTE

The contents of Memory Recall Mode display the selected display items in the current Display Modes instead of display items at the time when memorized.

Operation

1. Touch the [Display Mode] icon on the Memory Recall Mode.

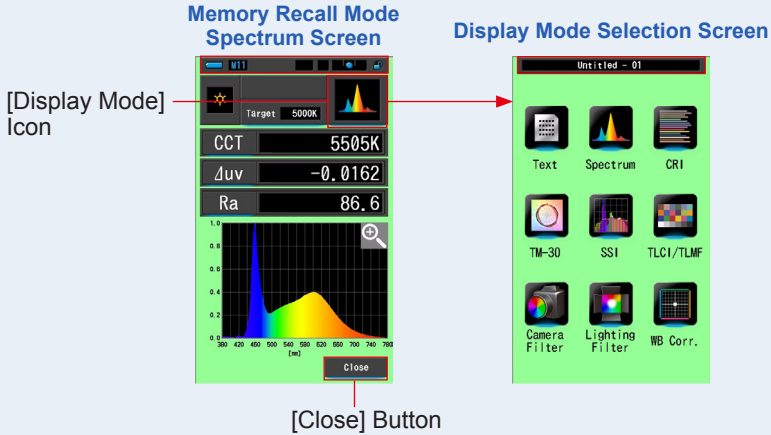
Display modes of Memory Recall Mode will be displayed. Memory Title of recalled value appears every two seconds on the status bar.



2. Touch the desired [Display Mode] icon to display.

Switches to each display mode screen.

3. Touch the [Close] button.

Returns to the Measuring screen.

6-2-3 Renaming Memory Title [Memory Rename] Screen

The title of measurements of the memory can be changed.

Memory Rename Screen

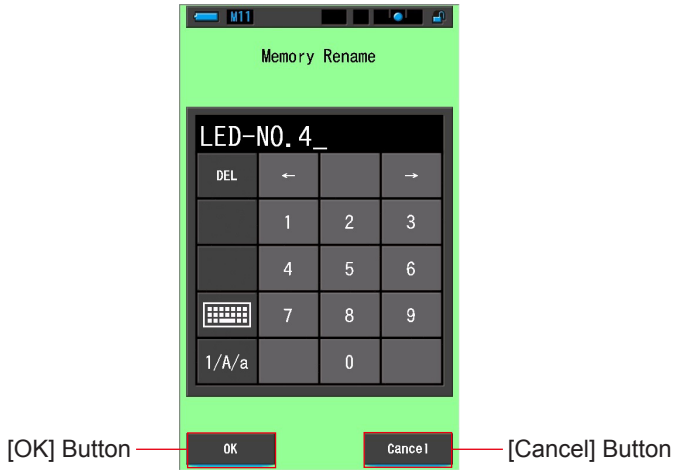

Operation

1. Touch the [Memory Management] button in the Tool Box.
Memory Management screen will be displayed.

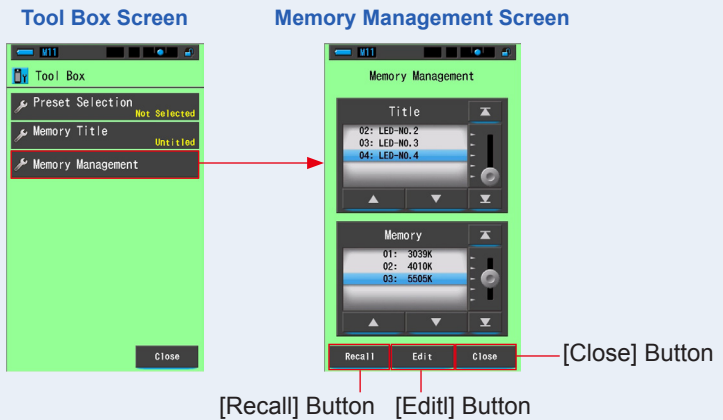

2. Touch the [Edit] button.

Memory Edit screen will be displayed.

Memory Management Screen



[Edit] Button

Memory Edit Screen

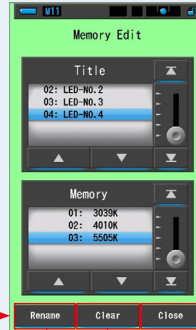

[Close] Button

[Rename] Button [Clear] Button

3. Select the "Title" and "Memory" to rename with the blue background positions.

4. Touch the [Rename] button.

Memory Rename screen will be displayed.

Memory Edit Screen



[Rename] Button

Memory Rename Screen



5. Enter the Memory Title to rename. (➔ P18)

Use the keyboard to create a name for the memorized value.

Memory Rename Screen



[OK] Button

[Cancel] Button

6. Touch the [OK] button.

Confirm and return to the Memory Edit screen.

To return to the “Memory Edit” screen without confirming, touch the [Cancel] button.

The memory title is entered.

7. Touch the [Close] button.

Close and return to the Memory Management screen. Touch the [Close] button to return to Measuring screen.

Memory Edit Screen



[Close] Button

Memory Management Screen

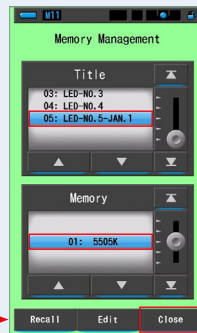

[Close] Button

6-2-4

Deleting Saved Measurement Results [Memory Clear] Screen

You can delete memorized measurement values individually or every Memory Title at once.

In Memory Clear, titles and memory contents (memory numbers and measurement values) are displayed in the registered order.

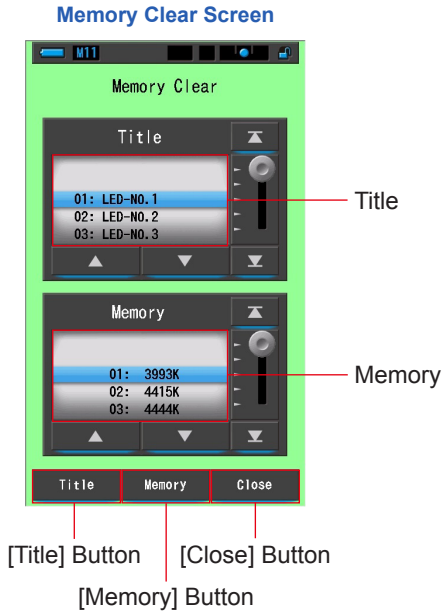

Operation

1. Touch and select the [Memory Management] button in the Tool Box.

The Memory Clear screen will be displayed.

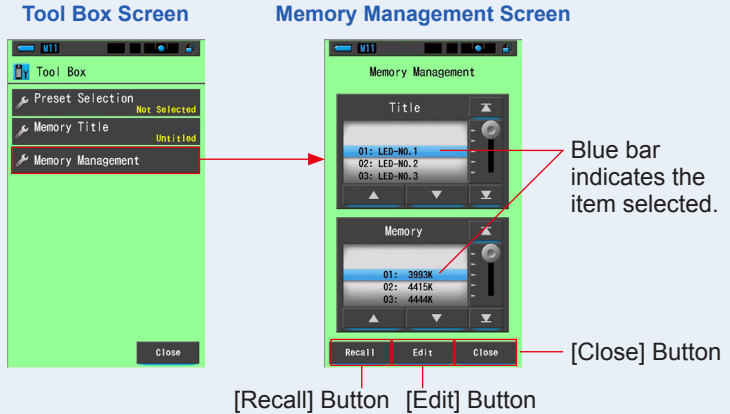

2. Touch the [Edit] button.

Memory Edit screen will be displayed.

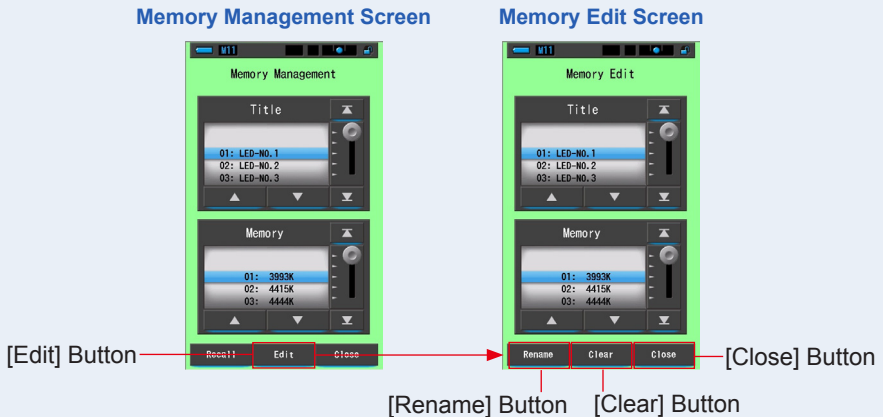

3. Select the "Title" and "Memory" to clear with the blue background positions.

4. Touch the [Clear] button.

Memory Clear screen will be displayed.

Memory Edit Screen



[Clear] Button

Memory Clear Screen

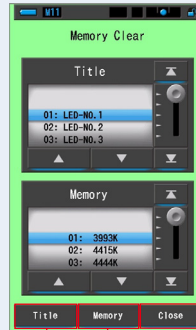

[Close] Button

[Title] Button [Memory] Button

[Erasing Individual Values]

1. Select the Title to display the memorized value you want to delete. Then select the specific light source value under that title, if more than one value has been memorized.
2. Touch the [Memory] button.

This will display the Memory Clear Confirmation screen. "Remove the selected memory data. Are you sure?" will be displayed.

Memory Clear Screen

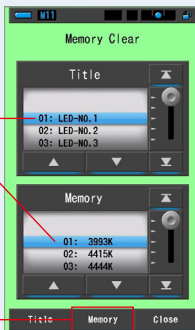

Select Title then the Memory that you want to clear.

[Memory] Button

Memory Clear Confirmation Screen



[Yes] Button

[No] Button

3. Touch the [Yes] button.

“Deleting Memory. Please wait.” will appear while the memory is being deleted. After the memory is cleared, the meter will return to the Memory Clear Screen.

While the progress bar is running, the deletion is in progress. The process may require time depending on the number of memories to be deleted. Do not perform other work.

You can clear (delete) additional memories by repeating steps 1-3.

If you decide not to delete a memory, touch the [No] button to return to the Memory Clear Screen.

Memory Clear Processing Screen

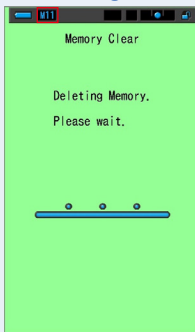

Memory Clear Screen

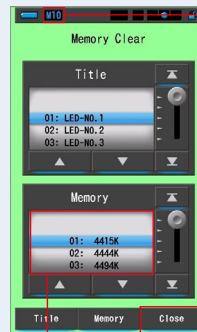

The memory number will change.

[Close] Button

The selected memory will be deleted, and the numbers after the selected number will decrease by one.

4. Touch the [Close] button.

Returns to the Memory Edit screen.

Touch the [Close] button until returning to Measuring screen.

[Erasing the Memory Title]

1. Match the "Title" to be deleted with the blue background positions.

Select the "Title" to be deleted.

2. Touch the [Title] button.

This will delete the title. All the memory data linked to the title will be deleted.

This will display the Memory Clear Confirmation screen. "Remove the selected memory title. Are you sure?" will be displayed.

Memory Clear Screen

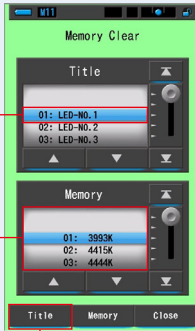

Move title into the blue background to select it.

All memorized measurements linked to the selected title will be displayed.

[Title] Button

Memory Clear Confirmation Screen

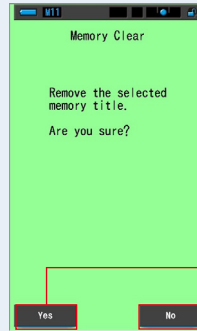

[Yes] Button

[No] Button

3. Touch the [Yes] button.

"Deleting Memory. Please wait." will be displayed. Returns to the Memory Clear screen after deletion.

While the progress bar is running, the deletion is in progress. The process may require time depending on the number of memories to be deleted. Do not perform other work.

If you do not want to delete the memorized values, touch the [No] button. Returns to the Memory Clear screen.

Memory Clear Processing Screen

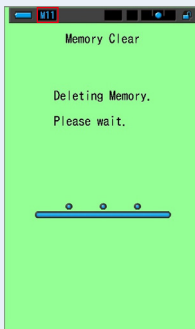

Memory Clear Screen

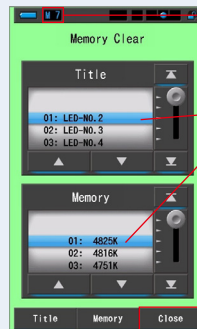

The memory number will change.

After the selected memory title and its linked data is deleted, the contents of title 01 are displayed.

[Close] Button

4. Touch the [Close] button.

Returns to the Memory Edit screen.

Touch the [Close] button until returning to Measuring screen.

7. Meter Settings [Setting] Screen

7-1 Setting Items

Here you can customize your meter for your preference in advance.

Display Mode Selection Screen

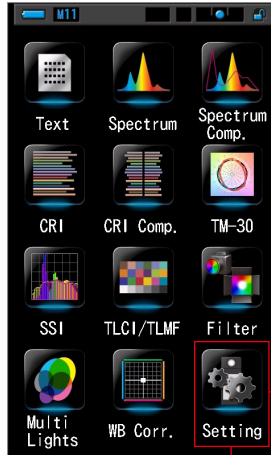

Setting Page 1 Screen

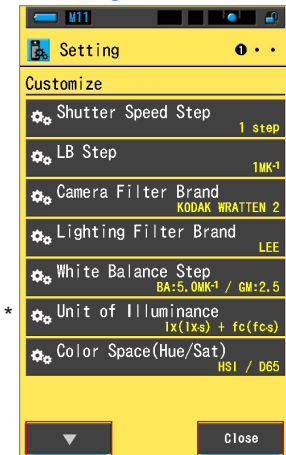

To page 2

Setting Page 2 Screen

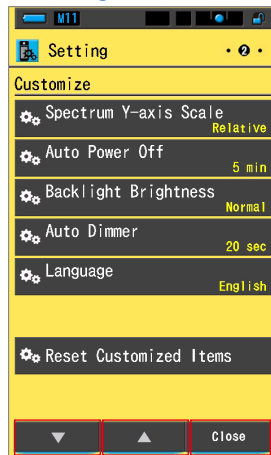

To page 3 To page 1

Setting Page 3 Screen

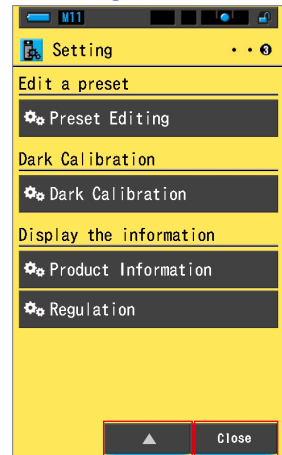

To page 2

[Close] Button

* Models sold in some countries do not display illuminance and exposure in "fc (fc-s)" due to legal restrictions. In this case, Unit of Illuminance is not displayed.

Operation

1. Touch the [Setting] icon on the Display Mode Selection screen.
Setting will be displayed.
2. Touch the one step icons [▲][▼] to display the desired page.
3. Touch the desired setting name.

That setting screen will be displayed.

When the [Close] button is touched, the display returns to the Display Mode Selection screen.



NOTE

Pressing the Menu Button ⑥ will exit the settings and return to the Display Mode Selection screen.

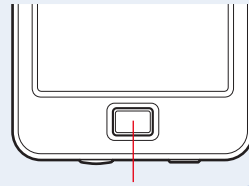

Menu Button ⑥

7-1-1 Item List

The Setting screen items are as follows.

Item Name	Description
Customize	
Shutter Speed Step	Select the shutter speed from 1 step, 1/3 step, and 1/2 step. (➔ P129)
LB Step	Select the LB index display step from 1MK^{-1} , 1daMK^{-1} (no decimal point) step, and 0.1daMK^{-1} (with decimal point) step. (➔ P132)
Camera Filter Brand	Select KODAK WRATTEN 2, FUJIFILM or LEE as the camera filter brand. (➔ P134)
Lighting Filter Brand	Select LEE, ROSCO CINEGEL or ROSCO E-COLOUR+ as the lighting filter brand. (➔ P136)
White Balance Step	Set the step for 1 grid square on the WB Corr. screen from the ranges below. BA: 0.5 to 100.0MK^{-1} GM: 0.5 to 20.0. (➔ P138)
Unit of Illuminance*	Select the unit from lx(lx·s), fc(fc·s) or both when measuring illuminance. (➔ P140)
Color Space (Hue/Sat)	Set the color space and white point to use for Hue/Saturation measurement from the ranges below. (➔ P142) Color space: HSV, HSI White point : D65, D55, D50, 3200K, 2800K
Spectrum Y-axis Scale	Select relative, auto, or spectral radiant intensity. (➔ P144)
Auto Power Off	Select the time before the power automatically turns off after last use (5min, 10min, 20min, No Auto Power Off). When No Auto Power Off is set, the automatic power OFF function is not activated. (➔ P147)
Backlight Brightness	Select the LCD backlight brightness from dark, normal, or bright. (➔ P149)
Auto Dimmer	Select the time before the backlight dims after last use to save extra power or adjust the visibility under the surrounding lighting conditions. (20sec, 40sec, 60sec, No Dimmer) (➔ P151)
Language	Select the language displayed on the touch panel from English, Japanese or Chinese. (➔ P153)
Reset Customized Items	Initialize (reset) only contents of "Customize" in Setting to the factory default (12 items). (➔ P155)
Edit a preset	
Preset Editing	Edit a preset separately. (➔ P156)
Dark Calibration	
Dark Calibration	Perform a dark calibration. (➔ P170)
Display the information	
Product Information	Display the product Information. (➔ P173)
Regulation	Display the complied regulations or certifications. (➔ P175)

* Models sold in some countries do not display illuminance and exposure in "fc (fc·s)" due to legal restrictions.

7-2

Customize

You can set the display contents of 12 items in Customize (P1 to 2 of Setting) to customize your meter for your preference.

The current setting for each item is displayed in yellow letters.

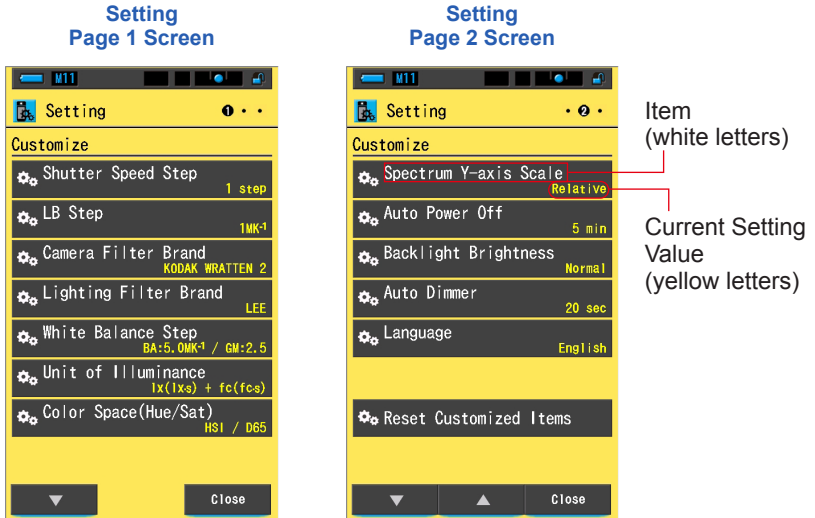

Operation

1. Touch the [Setting] icon on the Display Mode Selection screen.
Setting will be displayed.
2. Touch the one step icons [▲][▼] to display the desired page.
3. Touch the desired item.

The item screen will be displayed.

When the [Close] button is touched, the display returns to the Display Mode Selection screen.

7-2-1 Item Specifications

The specifications of each "Customize" item is as follows.

No.	Setting Name	Item				
						(Default)
1	Shutter Speed Step	1 Step	1/3 Step	1/2 Step	-	1 Step
2	LB Step	1MK ⁻¹ Step	1daMK ⁻¹ Step	0.1daMK ⁻¹ Step	-	1MK ⁻¹ Step
3	Camera Filter Brand	KODAK WRATTEN 2	FUJIFILM	LEE	-	KODAK WRATTEN 2
4	Lighting Filter Brand	LEE	ROSCO CINEGEL	ROSCO E-COLOUR+	-	LEE
5	White Balance Step	BA: 0.5 to 100.0MK ⁻¹ GM: 0.5 to 20.0				BA: 5MK ⁻¹ GM: 2.5
6	Unit of Illuminance*	lx(lx·s)+ fc(fc·s)	lx(lx·s)	fc(fc·s)	-	lx(lx·s)+ fc(fc·s)
7	Color Space (Hue/Sat)	Color space: HSV, HSI White point: D65, D55, D50, 3200K, 2800K				Color space: HSI White point: D65
8	Spectrum Y-axis Scale	Relative	Auto	Spectral Radiant Intensity 1.0μW to 100W·m ⁻² ·nm ⁻¹		Relative
9	Auto Power Off	5min	10min	20min	No Auto Power Off	5min
10	Backlight Brightness	Dark	Normal	Bright	-	Normal
11	Auto Dimmer	20sec	40sec	60sec	No Dimmer	20sec
12	Language	English	Japanese	Chinese	-	Selected by default
13	Reset Customized Items	When you touch the [OK] button, the Setting contents will be reset to factory default.				-

* Models sold in some countries do not display illuminance and exposure in "fc (fc·s)" due to legal restrictions.



NOTE

- 1MK⁻¹ is equivalent to 1Mired.
- The unit "MK⁻¹" is now used based on the International System of Units (SI) instead of traditional unit "Mired". The latest unit is adopted to the Spectrometer.

7-2-2

Selecting the Shutter Speed Step

Select the shutter speed from 1 step, 1/3 step, and 1/2 step.

Shutter Speed Step Screen

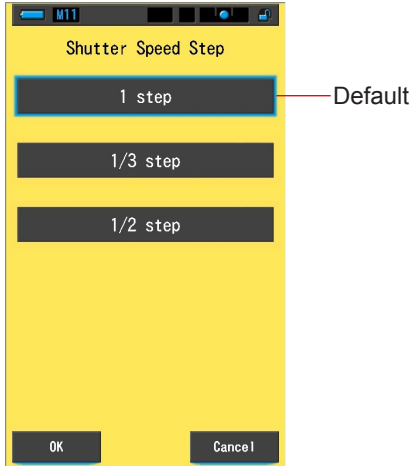

Selectable Shutter Speeds (in seconds)

1 Step (Default)	1, 1/2, 1/4, 1/8, 1/15, 1/30, 1/60, 1/125, 1/250, 1/500, 1/75, 1/80, 1/90, 1/100, 1/200, 1/400
1/3 Step	1, 0.8, 0.6, 0.5, 0.4, 0.3, 1/4, 1/5, 1/6, 1/8, 1/10, 1/13, 1/15, 1/20, 1/25, 1/30, 1/40, 1/50, 1/60, 1/80, 1/100, 1/125, 1/160, 1/200, 1/250, 1/320, 1/400, 1/500, 1/75, 1/80, 1/90, 1/100, 1/200, 1/400
1/2 Step	1, 0.7, 1/2, 1/3, 1/4, 1/6, 1/8, 1/10, 1/15, 1/20, 1/30, 1/45, 1/60, 1/90, 1/125, 1/180, 1/250, 1/350, 1/500, 1/75, 1/80, 1/90, 1/100, 1/200, 1/400

Operation

1. Touch the item [Shutter Speed Step] button on page 1 of Setting.
The shutter speed step will be displayed.

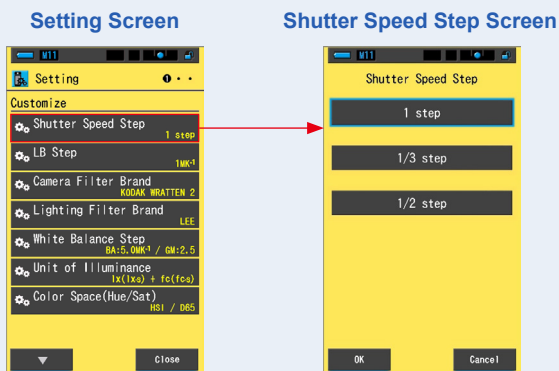

2. Touch the desired shutter speed step to use.
Select from 1 step, 1/3 step, or 1/2 step.

Shutter Speed Step Screen



[OK] Button [Cancel] Button

3. Touch the [OK] button.

Confirms the settings, and returns to Setting screen.

To return to the Setting screen without confirming, touch the [Cancel] button.

Setting Screen



The set content is displayed.

The shutter speed step is set.

7-2-3 Selecting the LB Step

Select the LB index display step from 1MK^{-1} , 1daMK^{-1} (no decimal point) step, and 0.1daMK^{-1} (with decimal point) step.

Ex) 38MK^{-1} is displayed as 38MK^{-1} in 1MK^{-1} step, 4MK^{-1} in 1daMK^{-1} step, and 3.8MK^{-1} in 0.1daMK^{-1} step.

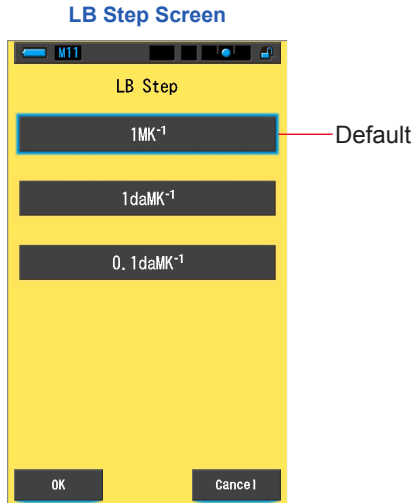

Operation

1. Touch the item [LB Step] button on page 1 of Setting.
The LB step will be displayed.

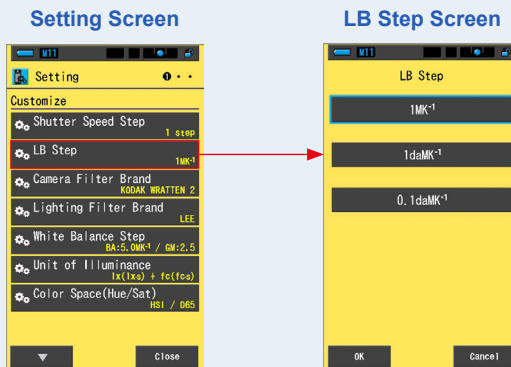

2. Touch the desired LB step value to use.

Select the LB Step value.

LB Step Screen

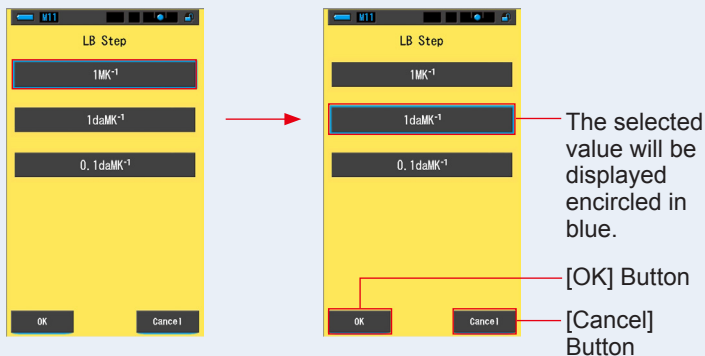

Measurement Screen Display Example



3. Touch the [OK] button.

Confirms the settings, and returns to Setting screen.

To return to the Setting screen without confirming, touch the [Cancel] button.

Setting Screen

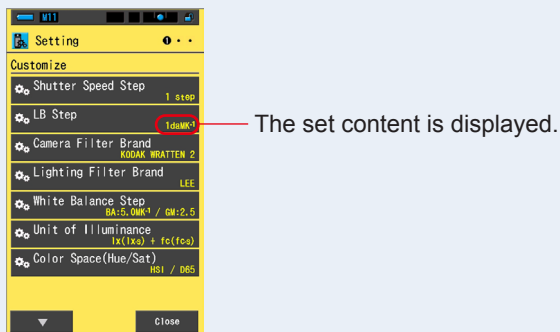

The LB step is set.



NOTE

- 1MK^{-1} is equivalent to 1Mired.
- The unit "MK⁻¹" is now used based on the International System of Units (SI) instead of traditional unit "Mired". The latest unit is adopted to the Spectrometer.

7-2-4

Selecting the Camera Filter Brand

Select KODAK WRATTEN 2, FUJIFILM or LEE as the camera filter brand.

Camera Filter Brand Screen

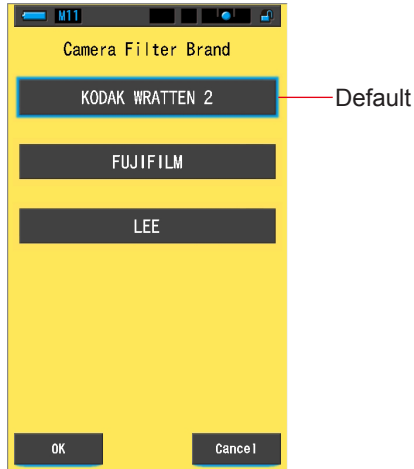

Operation

1. Touch the item [Camera Filter Brand] button on page 1 of Setting.
The camera filter brand will be displayed.

Setting Screen



Camera Filter Brand Screen

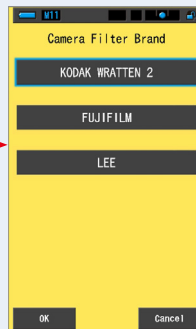

2. Touch the desired camera filter brand to use.

Select the filter brand of the camera used.

Camera Filter Brand Screen

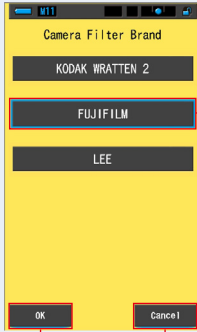

The selected brand will be displayed encircled in blue.

[OK] Button

[Cancel] Button

3. Touch the [OK] button.

Confirms the settings, and returns to Setting screen.

To return to the Setting screen without confirming, touch the [Cancel] button.

Setting Screen



The set content is displayed.

The camera filter brand is set.

7-2-5

Selecting the Lighting Filter Brand

Select LEE, ROSCO CINEGEL, or ROSCO E-COLOUR+ as the lighting filter brand.

Lighting Filter Brand Screen

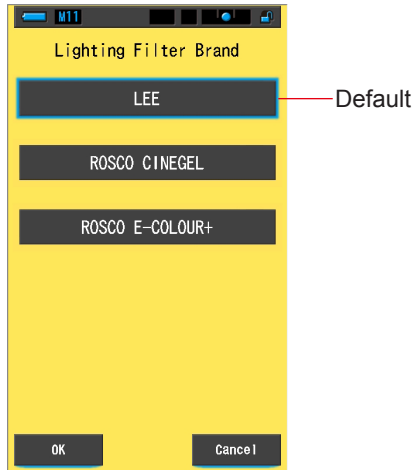

Operation

1. Touch the [Lighting Filter Brand] button on page 1 of Setting.
The lighting filter brand will be displayed.

Setting Screen



Lighting Filter Brand Screen

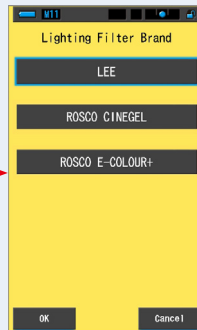

2. Touch the desired filter brand to use.

Select the filter brand of the lighting used.

Lighting Filter Brand Screen



The selected brand will be displayed encircled in blue.

[OK] Button

[Cancel] Button

3. Touch the [OK] button.

Confirms the settings, and returns to Setting screen.

To return to the Setting screen without confirming, touch the [Cancel] button.

Setting Screen

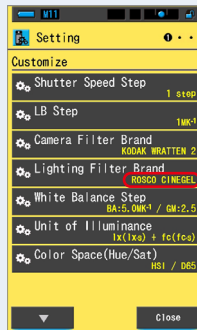

The set content is displayed.

The lighting filter brand is set.

7-2-6 Selecting the White Balance Step

Select the unit per step displayed per grid cell on the WB Corr. Mode measurement screen from a range of BA: 0.5 to 100.0MK⁻¹, GM: 0.5 to 20.0.

Some cameras have white balance function, however, the setting of grid cell varies depending on the cameras. Match the setting to the camera.

White Balance Step Screen

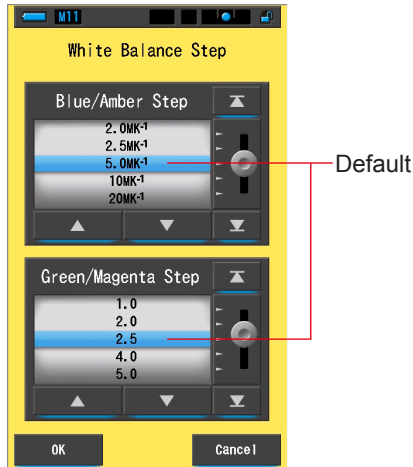

Operation

1. Touch the item [White Balance Step] button on page 1 of Setting.
The white balance step will be displayed.

Setting Screen

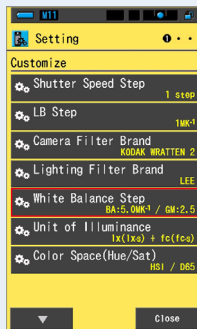

White Balance Step Screen

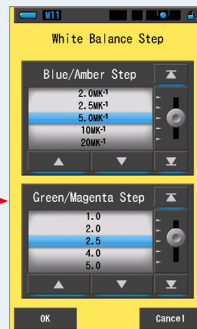

2. Select the desired white balance step to use.

White Balance Step Screen

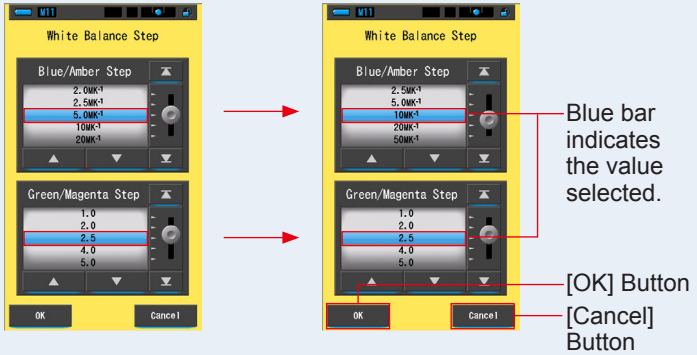

Measurement Screen Display Example

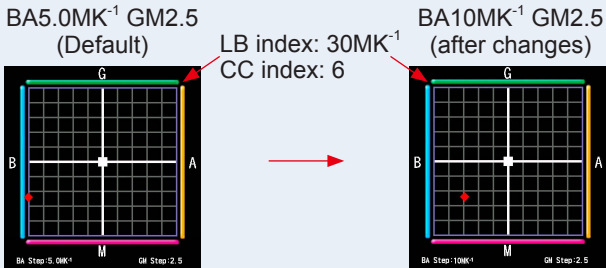

3. Touch the [OK] button.

Confirms the settings, and returns to Setting screen.

To return to the Setting screen without confirming, touch the [Cancel] button.

Setting Screen

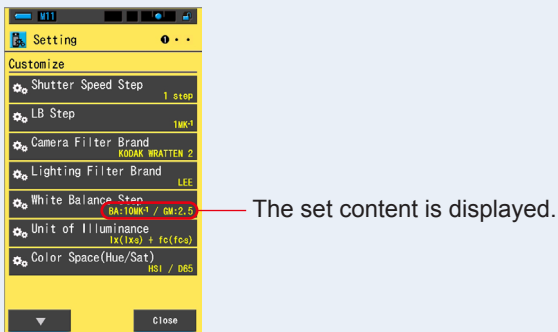

The white balance step is set.

7-2-7

Selecting the Unit of Illuminance

Select the unit when measuring illuminance.

* Models sold in some countries do not display illuminance and exposure in "fc (fc·s)" due to legal restrictions. In this case, "Unit of Illuminance" button will not appear in Setting screen.

Unit of Illuminance Screen

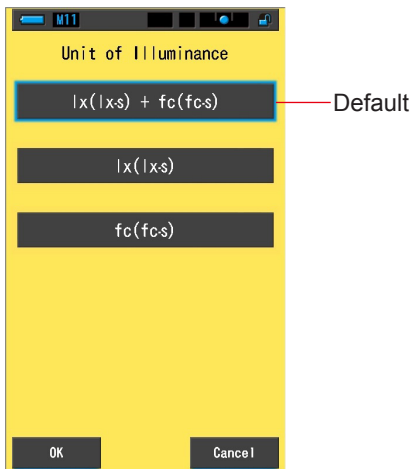

Operation

1. Touch the item [Unit of Illuminance] button on page 1 of Setting.
The unit of illuminance will be displayed.

Setting Screen



Unit of Illuminance Screen

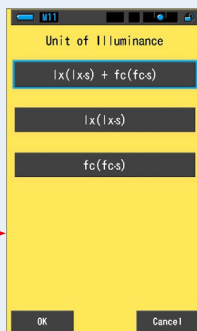

2. Touch the desired unit to use.

Select the unit of illuminance.

Unit of Illuminance Screen

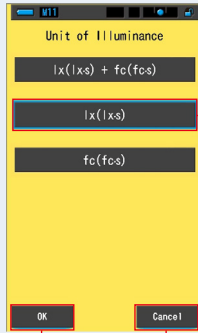

The selected button will be displayed encircled in blue.

[OK] Button

[Cancel] Button

3. Touch the [OK] button.

Confirms the settings, and returns to Setting screen.

To return to the Setting screen without confirming, touch the [Cancel] button.

Setting Screen



The set content is displayed.

The unit of illuminance is set.

7-2-8 Selecting the Color Space (Hue/Sat)

Set the color space (HSV, HSI) and white point (D65, D55, D50, 3200K, 2800K) to use for Hue/Saturation measurement.

Color Space (Hue/Sat) Screen

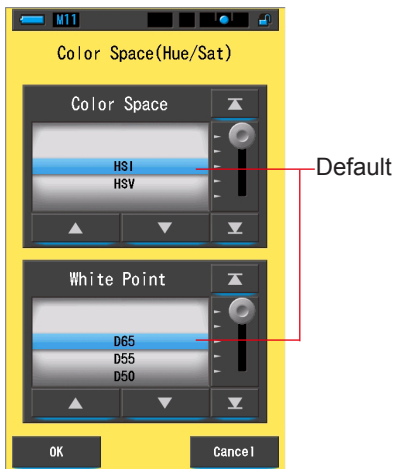

Operation

1. Touch the item [Color Space (Hue/Sat)] button on page 1 of Setting screen.

The Color Space (Hue/Sat) will be displayed.

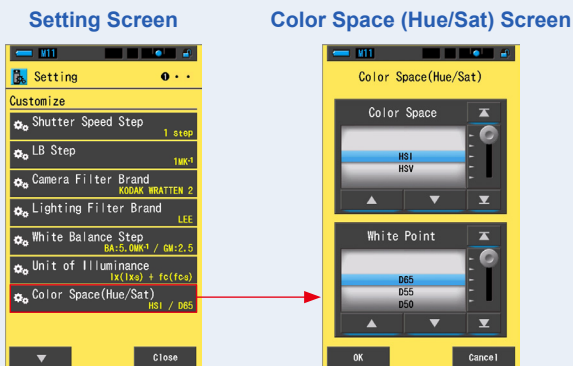

2. Select the color space to use (HSI or HSV), and white point (D65 to 2800K).

Color Space (Hue/Sat) Screen

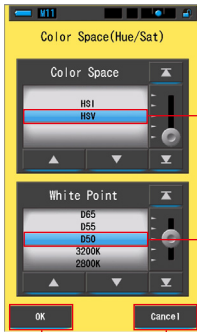

The selected button will be displayed encircled in blue.

[OK] Button [Cancel] Button

3. Touch the [OK] button.

Confirms the settings, and returns to Setting screen.

To return to the Setting screen without confirming, touch the [Cancel] button.

Setting Screen

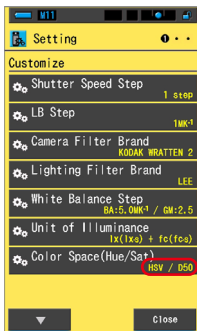

The set content is displayed.

The Color Space (Hue/Sat) is set.



NOTE

Three primaries R/G/B used to calculate the color space are Sekonic own values. Also, depending on the set white point, the set value of your lighting equipment may vary from the measured value of the meter.

7-2-9

Selecting the Spectrum Y-axis Scale

Select Relative, Auto, or any specific number of spectral irradiance as the maximum display value for the spectrum Y-axis.

Spectrum Y-axis Scale Screen

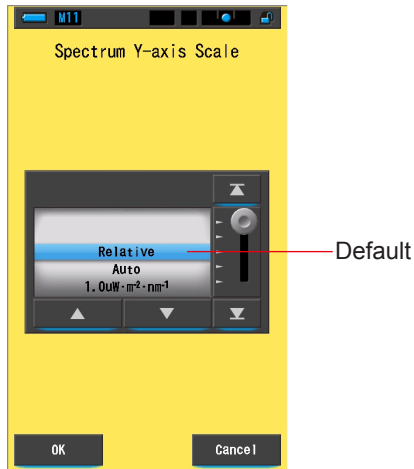

Operation

1. Touch the item [Spectrum Y-axis Scale] button on page 2 of Setting.

The maximum display value of the spectrum Y-axis scale will be displayed.

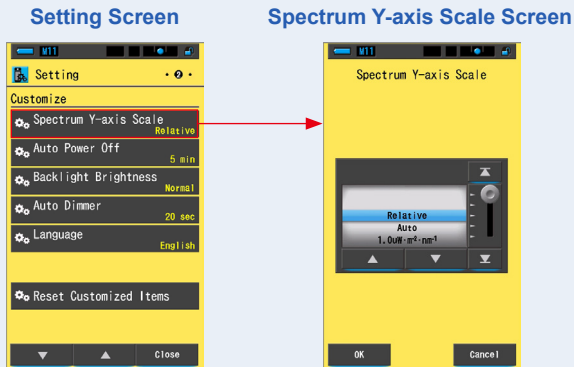

2. Select the desired spectrum Y-axis scale.

Select from relative, auto, or spectral radiant intensity.

Spectrum Y-axis Scale Screen

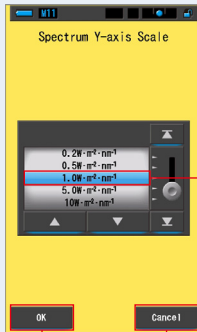

Blue bar indicates the value selected.

[OK] Button

[Cancel] Button

3. Touch the [OK] button.

Confirms the setting, and returns to Setting screen.

To return to the Setting screen without confirming, touch the [Cancel] button.

Setting Screen

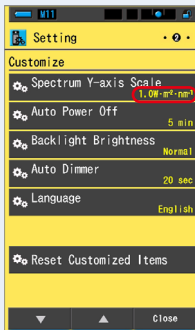

The set content is displayed.

The spectrum Y-axis scale is set.



- Relative.....Regardless of brightness of light source, the peak of brightness in each measurement and memorized values is regarded as 1.0 to compare the light sources in shape of spectrum graph.
- AutoThe appropriate Y-axis value is automatically selected and spectral irradiance can be compared.
- Spectral IrradianceSpecific value can be selected from 1.0u to 100 W·m⁻²·nm⁻¹.

Relative

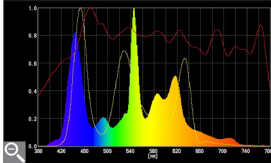

Auto

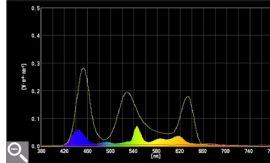

Spectral Irradiance

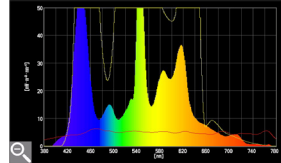

7-2-10

Selecting the Auto Power Off Time

Select the time before the power automatically turns off after last use (5min, 10min, 20min, No Auto Power Off). When No Auto Power Off is set, the automatic power OFF function is not activated.

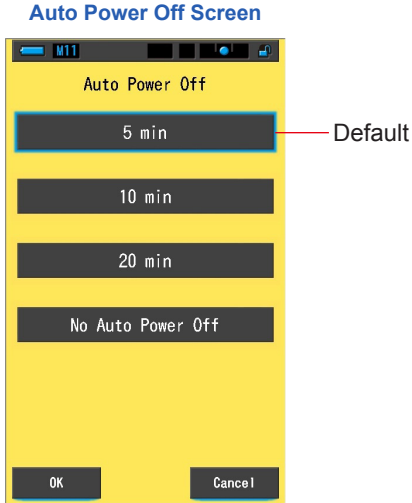

Operation

1. Touch the item [Auto Power Off] button on page 2 of Setting.
The auto power off time will be displayed.

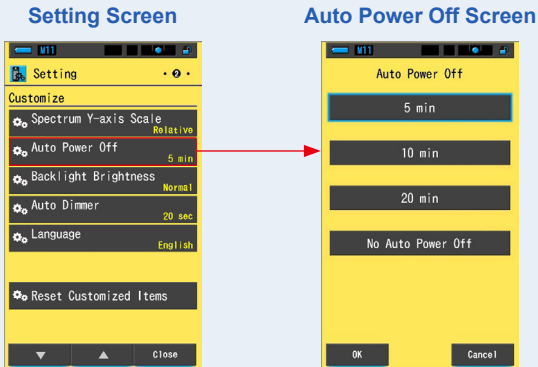

2. Touch the desired time on the Auto Power Off screen.

Select 5min, 10min, 20min, or No Auto Power Off.

Auto Power Off Screen

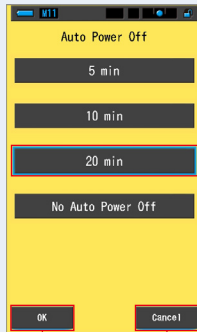

The selected button will be displayed encircled in blue.

[OK] Button

[Cancel] Button

3. Touch the [OK] button.

Confirms the settings, and returns to Setting screen.

To return to the Setting screen without confirming, touch the [Cancel] button.

Setting Screen

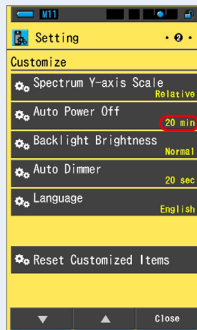

The set content is displayed.

The auto power off time is set.

7-2-11

Selecting the Backlight Brightness

Select the LCD backlight brightness from Dark, Normal or Bright to save extra power or adjust the visibility under the surrounding light condition.

Backlight Brightness Screen



Operation

1. Touch the item [Backlight Brightness] button on page 2 of Setting.

The backlight brightness will be displayed.



- 2. Touch the desired brightness on the Backlight Brightness screen.**
Select dark, normal or bright.

Backlight Brightness Screen

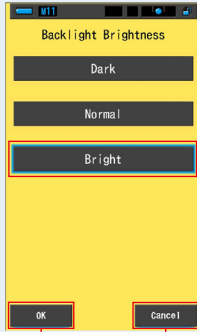

The selected button will be displayed encircled in blue.

[OK] Button [Cancel] Button

- 3. Touch the [OK] button.**

Confirms the settings, and returns to Setting screen.

To return to the Setting screen without confirming, touch the [Cancel] button.

Setting Screen

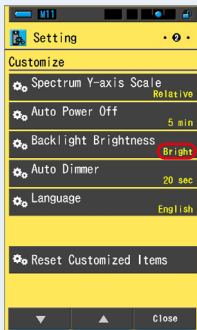

The set content is displayed.

The backlight brightness is set.

7-2-12 Selecting the Auto Dimmer Time

Select the time before the backlight dims after last use to save extra power.
(20sec, 40sec, 60sec, No Dimmer)

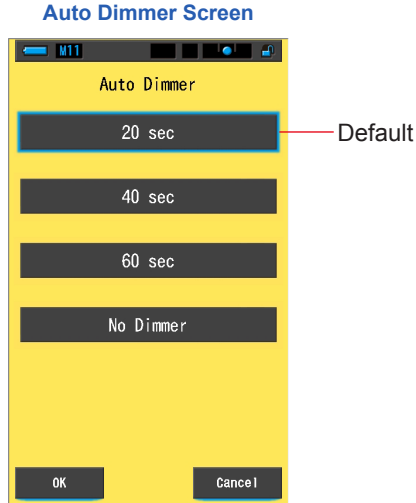

Operation

1. Touch the [Auto Dimmer] button on page 2 of Setting.
The auto dimmer time will be displayed.

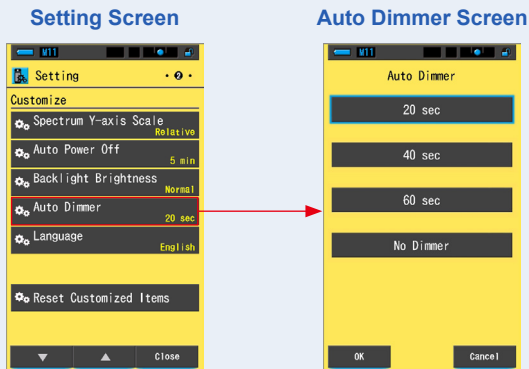

2. Touch the desired time on the Auto Dimmer screen.

Select 20sec, 40sec, 60sec, or No Dimmer.

Auto Dimmer Screen

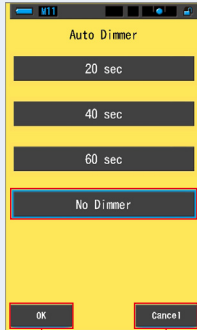

The selected button will be displayed encircled in blue.

[OK] Button [Cancel] Button

3. Touch the [OK] button.

Confirms the settings, and returns to Setting screen.

To return to the Setting screen without confirming, touch the [Cancel] button.

Setting Screen

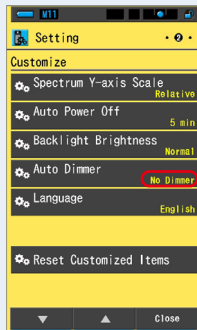

The set content is displayed.

The auto dimmer time is set.

7-2-13 Selecting the Language

Select the language displayed in the meter from English, Japanese or Chinese.



Operation

1. Touch the item [Language] button on page 2 of Setting.
The language will be displayed.

* You can change the language set when power is turned on for the first time.

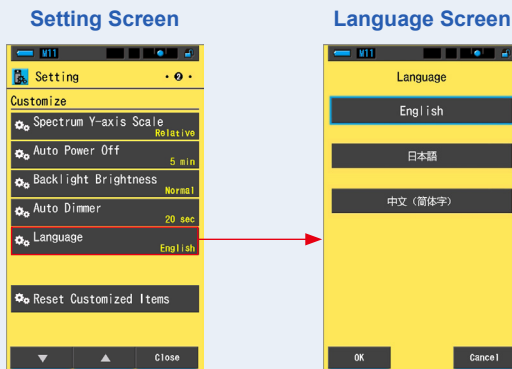

2. Touch the desired language to use.

Select English, Japanese or Chinese.

Language Screen

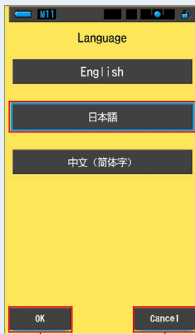

The selected button will be displayed encircled in blue.

[OK] Button [Cancel] Button

3. Touch the [OK] button.

Confirms the settings, and returns to Setting screen.

To return to the Setting screen without confirming, touch the [Cancel] button.

Setting Screen

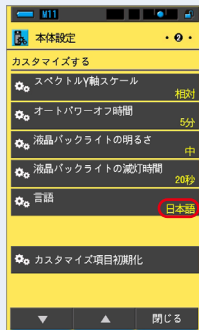

The set content is displayed.

The language is set.

7-2-14 Reset Customized Items

Initialize (reset) only contents of "Customize" in Setting to the factory default.

Reset Customized Items Screen

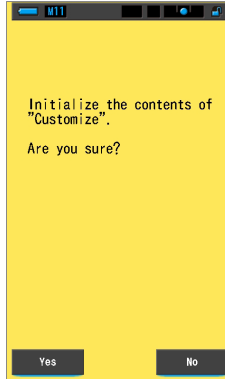

Operation

1. Touch the item [Reset Customized Items] button on page 2 of Setting.

"Initialize the contents of "Customize". Are you sure?" is displayed.

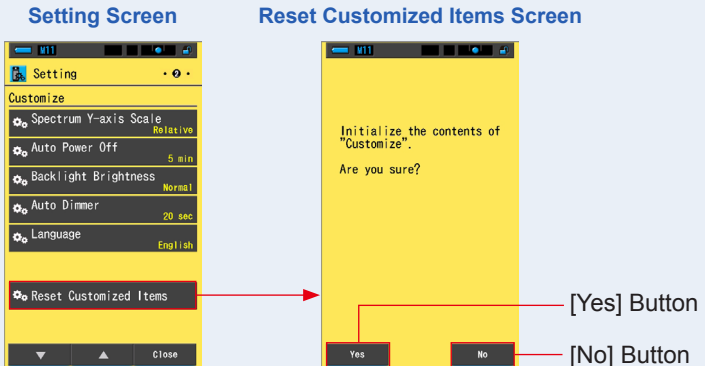

2. Touch the [Yes] button.

Custom settings are reset. After finishing initialization, returns to Setting screen.

To return to the Setting without initializing, touch the [No] button.

7-3 Preset Editing

Presets are a quick way to introduce adjustments to the camera/light source filter recommendations.

You can create and store Presets for different lighting conditions or color effects to use when ever needed.

The Spectrometer has been calibrated to Sekonic standards. However if the indicated compensating values do not yield the desired or expected color reproduction, than it will be necessary to modify the filter compensation values. In this case, if you save the compensation values in memory as a preset number and then take measurements, you can display results with the compensated values.

Also, when you use several target color temperatures, you can easily set the target color temperature by recalling one of presents in Tool Box even if you do not input a target color temperature every time.

Preset Editing Screen

The screenshot shows the 'Preset Editing' screen with the following fields and values:

Preset No.	1
Preset Selection List	Hide
Preset Name	Default-D01
Target CCT	5000K
LB Index Correction Value	0M ⁻¹
CC Index Correction Value	0.0

A 'Close' button is located at the bottom right of the screen.



Up to 19 presets can be registered.

Operation

1. Touch the item [Preset Editing] button on page 3 of Setting.
The Preset Editing screen of Setting will be displayed.

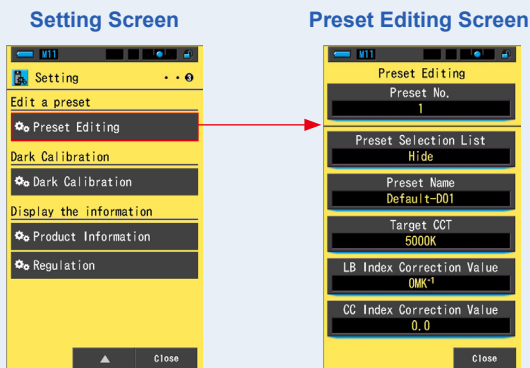

2. Touch the [Preset No.] button.
The preset number is displayed.

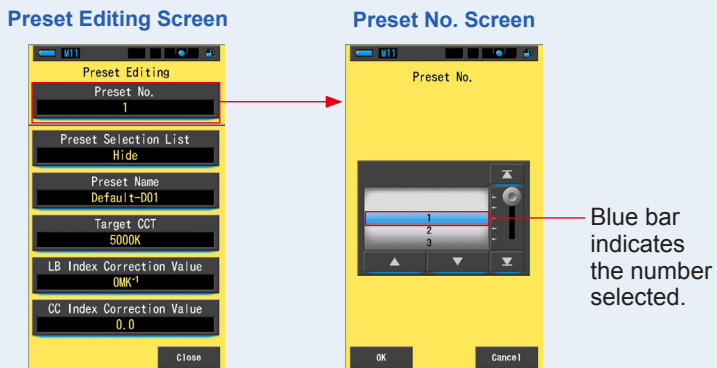

3. Select the desired present number (1 ~ 19) to edit.

Preset No. Screen

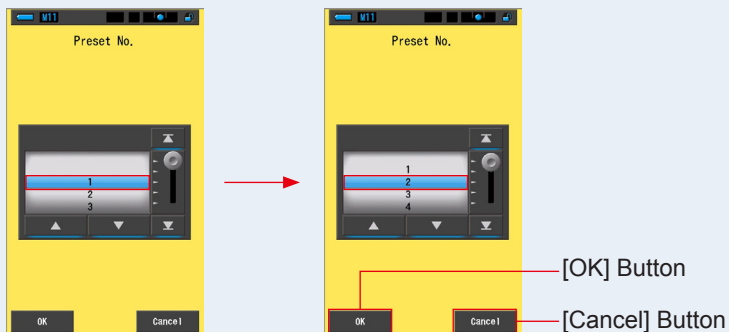

4. Touch the [OK] button.

The number is fixed, and returns to the Preset Editing screen.

The desired preset number to edit is displayed.

To return to the Preset Editing screen without confirming, touch the [Cancel] button.

Preset Editing Screen

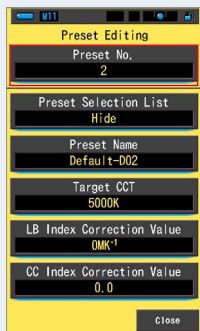

5. Edit each setting item.

Refer to the follow reference pages for editing each setting item.

- Preset Selection List (➔ P159)
- Preset Name (➔ P161)
- Target CCT (➔ P163)
- LB Index Correction Value (➔ P166)
- CC Index Correction Value (➔ P168)

6. Touch the [Close] button.

Returns to Setting screen.

Preset editing is complete.

7-3-1

Displaying the Preset Selection List

Select to display or not in the Preset Selection list in the Tool Box.

Display in the Preset Selection List Screen

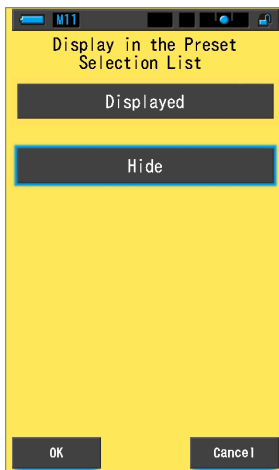

Operation

1. Touch the [Preset Selection List] button.

Display in the Preset Selection List will appear.

Preset Editing Screen

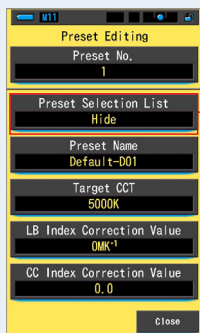

Display in the Preset Selection List Screen

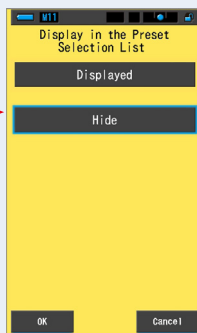

2. Select the [Displayed] to set.

The selected icon will be displayed encircled in blue.

Display in the Preset Selection List Screen

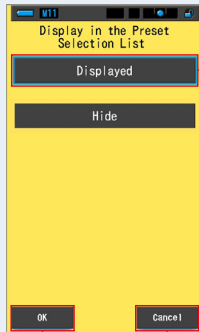

The selected button will be displayed encircled in blue.

[OK] Button [Cancel] Button

3. Touch the [OK] button.

The set item is fixed, and returns to the Preset Editing screen.

To return to the Preset Editing screen without confirming, touch the [Cancel] button.

Preset Editing Screen

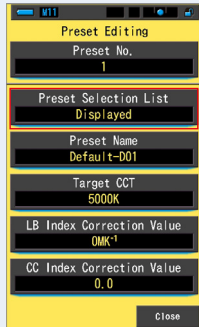

The Preset Selection List is set.

7-3-2 Setting the Present Name

Edit the preset name.

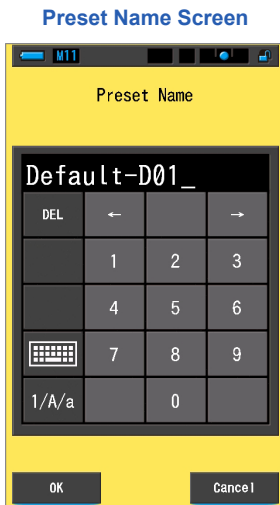

NOTE

Up to 16 alphanumeric characters can be input for Preset name.

Operation

1. Touch the [Preset Name] button.

The Preset Name Input screen is displayed.

Preset Editing Screen

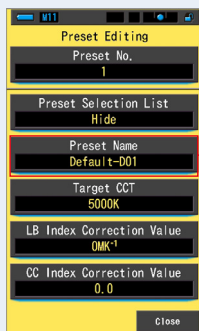

Preset Name Screen

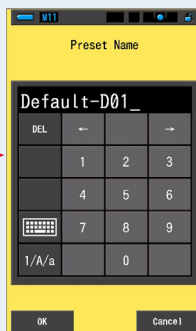

2. Use the keyboard to create a name for preset. (→ P18)

Preset Name Screen

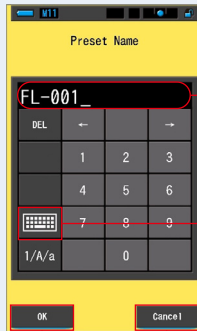

Input number

Keypad (Upper Case Input Screen)



[OK] Button [Cancel] Button

3. Touch the [OK] button.

The Preset name is fixed, and returns to Preset Editing screen.

To return to the Preset Editing screen without confirming (registering/editing), touch the [Cancel] button.

Preset Editing Screen

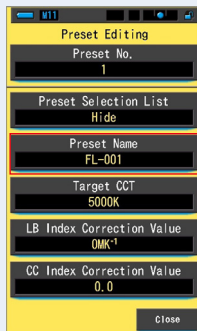

The preset name is set.

7-3-3 Setting the Preset Target Color Temperature

Input the target color temperature for preset.

Target CCT Screen

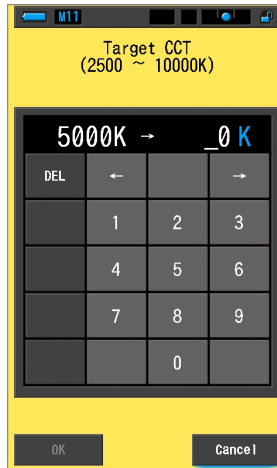

Operation

1. Touch the [Target CCT] button.

The Target CCT screen will be displayed.

Preset Editing Screen

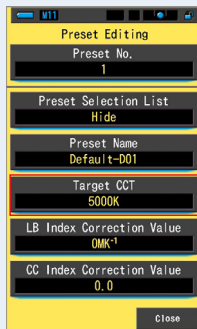

Target CCT Screen

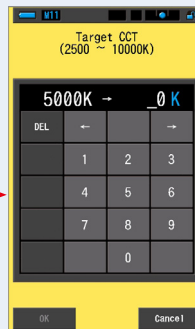

2. Enter the value of the target color temperature. (→ P17)

* The units place is fixed as 0.

Target CCT Screen

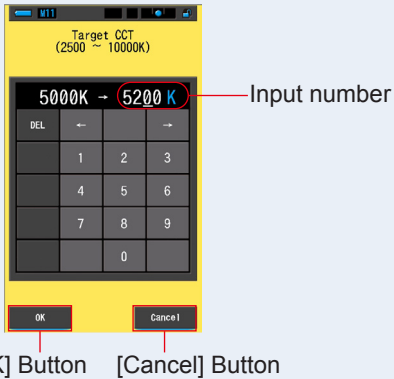

3. Touch the [OK] button.

The number is fixed, and returns to the Preset Editing screen.

To return to the Preset Editing screen without confirming, touch the [Cancel] button.

Preset Editing Screen

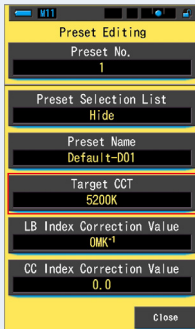

The target color temperature is edited.

**NOTE**

- Set the meter to the same color temperature that was selected in your camera. Please note that many digital cameras reproduce color better at certain color temperature settings. If your work requires optimum color reproduction and high color fidelity, select the camera manufacturers recommended color temperature for best color reproduction. Please refer to your digital camera's operating manual.
- You can set the color temperature from 2,500K to 10,000K.
- When you frequently use several target color temperatures, use preset for convenience.

7-3-4

Setting the LB Index Correction Value

Sets the preset LB index Correction value.

LB Index Correction Value Screen

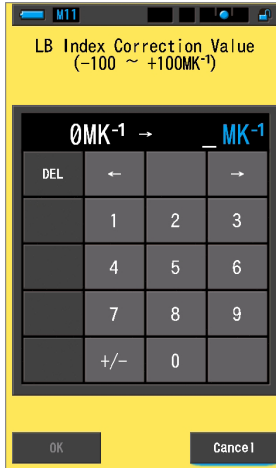

Operation

1. Touch the [LB Index Correction Value] button.

The LB index correction value will be displayed.

Preset Editing Screen

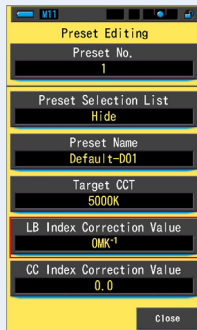

LB Index Correction Value Screen



2. Set the correction value within a range of $\pm 100\text{MK}^{-1}$. (⇒ P17)

LB Index Correction Value Screen

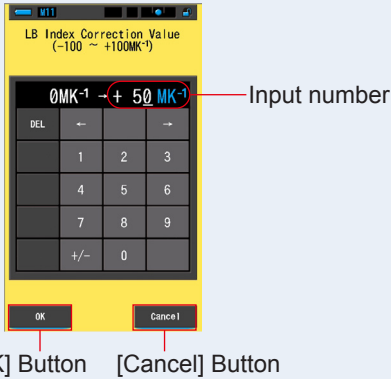

NOTE

When input, the value becomes automatically positive (+) number. If you change the positive (+) or negative (-) number, touch the [+/-] key.

3. Touch the [OK] button.

The number is fixed, and returns to the Preset Editing screen.

To return to the Preset Editing screen without confirming, touch the [Cancel] button.

Preset Editing Screen

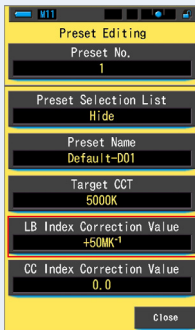

The LB index correction value is edited.

7-3-5 Setting the CC Index Correction Value

Sets the preset CC index Correction value.

CC Index Correction Value Screen

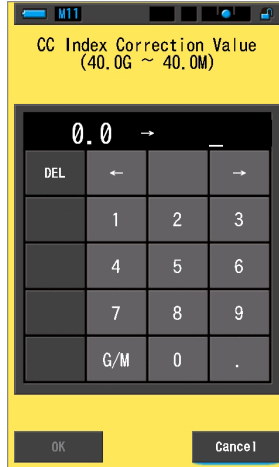

Operation

1. Touch the [CC Index Correction Value] button.

The CC index correction value will be displayed.

Preset Editing Screen

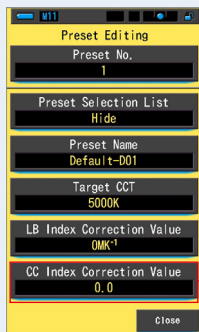

CC Index Correction Value Screen



2. Set the CC index correction value within a range of 40.0G ~ 40.0M.
(⇒ P17)

CC Index Correction Value Screen

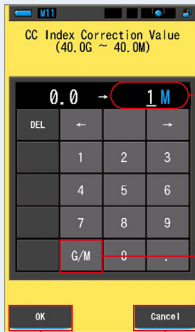

Input number

Press "G/M" to switch between green and magenta

[OK] Button

[Cancel] Button

3. Touch the [OK] button.

The number is fixed, and returns to the Preset Editing screen.

To return to the Preset Editing screen without confirming, touch the [Cancel] button.

Preset Editing Screen

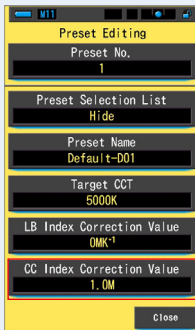

The CC index correction value is edited.



NOTE

Because the CC index correction value unit is an index, 1 of CC index is equivalent to 2.5 CC filter number.

7-4 Dark Calibration

Dark calibration is performed when there is a big change in temperature between turning power OFF and ON.
 Except the cases above, dark calibration after power ON is skipped.
 Accordingly, if you want to perform dark calibration manually, do it from this screen.

Dark Calibration Confirmation Screen

Light Selection Ring Status Indicator Chart

Icon		Content
		If either of icons appears, set the Light Selection Ring ② to the dark calibration position.
	CAL	This icon is the dark calibration position. Perform dark calibration after making sure it is set to this position.

Operation

1. Touch the item [Dark Calibration] button on page 3 of Setting.
 "Perform Dark Calibration?" will be displayed.

Setting Screen

Dark Calibration Confirmation Screen

2. Turn the Light Selection Ring ② to set to the dark calibration position CAL ().

The status bar will display the dark calibration icon.

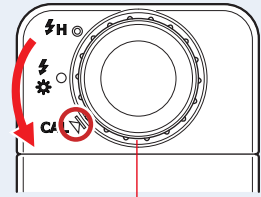
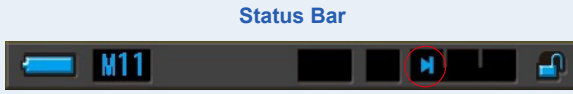

Light Selection Ring ②

3. Touch the [Yes] button.

"Dark calibration in progress. Please wait" and the status bar will appear while calibrating.

To return to the Setting screen without performing dark calibration, touch the [No] button.

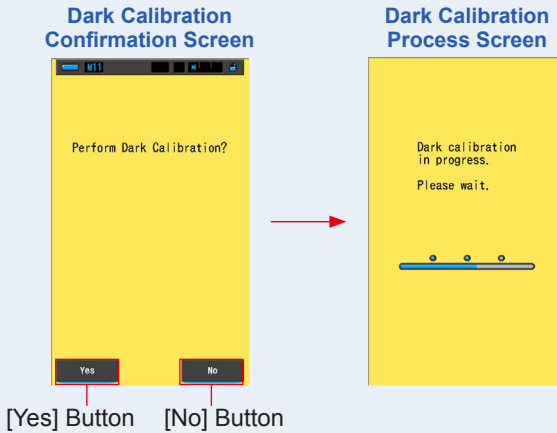

NOTICE

While the message "Dark calibration in progress. Please wait." or the progress bar is displayed, do not turn the power off.

The dark calibration is completed.

When the Following Screen is Displayed

Dark Calibration Position Confirmation Screen



The Light Selection Ring ② is set to Range H (⚡) or Range L (⚡), and dark calibration could not be performed.

Set the Light Selection Ring ② to the dark calibration position **CAL** (🔌), and perform dark calibration.

Dark Calibration failure Screen

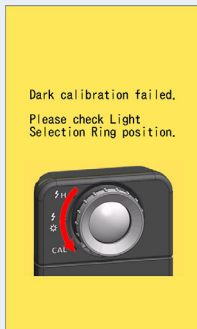

While the dark calibration is being performed, the position of Light Selection Ring ② is changed. so dark calibration could not be completed normally. Set the Light Selection Ring ② to the dark calibration position **CAL** (🔌) again, and perform dark calibration again.

NOTE

- Dark calibration can be done by turning the Light Selection Ring ② to set to the dark calibration position **CAL** (🔌) in Measuring Screen and Display Mode Selection screen.
- Dark calibration is performed when there is a big change in temperature between turning power OFF and ON. Except the cases above, dark calibration after power ON is skipped.

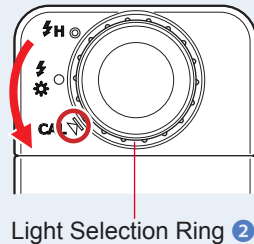

7-5 Product Information Display

The Product Information screen displays detailed information not displayed in the Measurement screen.

Product Information Screen

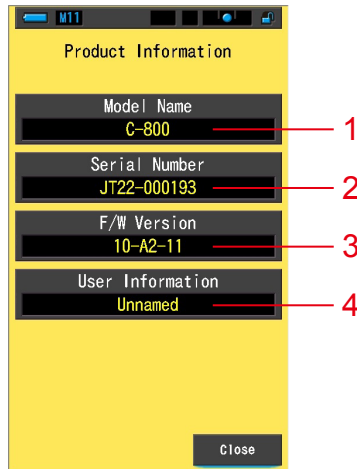

* The screen contents differs depending on model.

No.	Item Name	Description
1	Model Name	Displays the model number of the meter.
2	Serial Number	Displays the serial number of the meter.
3	F/W Version	Displays the firmware version.
4	User Information	Displays user-input information such as ownership or meter function, etc which is set in the "Hardware Setting Screen". (➔ P176)

Operation

1. Touch the item [Product Information] button on page 3 of Setting.
The Product Information screen will be displayed.

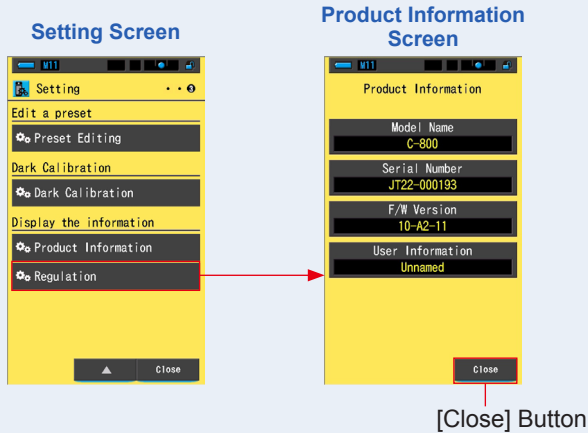

2. Touch the [Close] button.
Returns to the Setting screen.

7-5-1 Regulation Display

The Regulation screen displays the symbols, approved number, regulation names, etc. which the meter is compliance with.

Regulation Screen

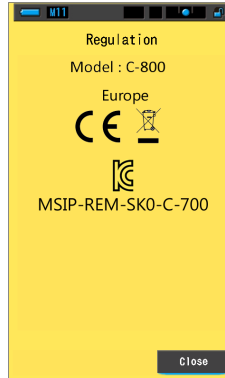

Operation

1. Touch the item [Regulation] button on page 3 of Setting.

The Regulation screen will be displayed.

The display contents will differ depending on the product you have purchased.

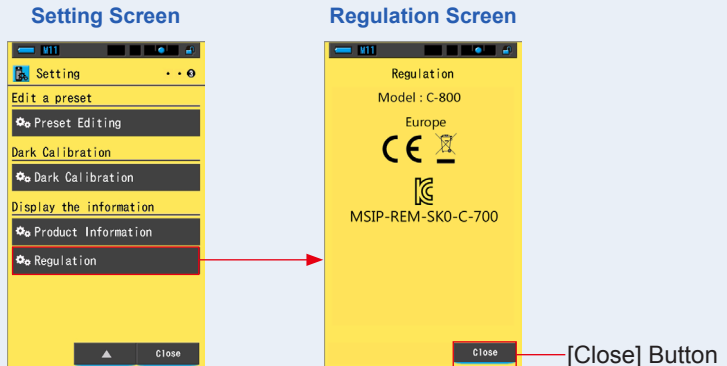

2. Touch the [Close] button.

Returns to the Setting screen.

8. Hardware Setting Screen

You can set the follow on the Hardware Setting screen.

- Adjust Touch Panel
- Edit User Information
- Factory Setting

Hardware Setting Screen

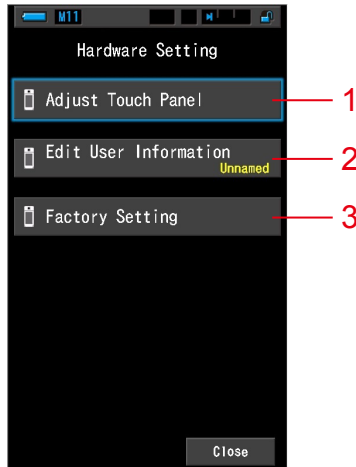

No.	Item Name	Description
1	Adjust Touch Panel	Adjust the position of touch panel display. (➡ P178)
2	Edit User Information	Edit user information to display the User Information screen in Setting. (➡ P181)
3	Factory Setting	Returns all display and setting contents to the factory default. (➡ P183)

Operation

1. With the meter turned OFF, hold down the Menu Button ⑥ and press the Power Button ③ .

* Until the Hardware Setting screen is displayed, do not release the Menu Button ⑥ and the Power Button ③ .

If you release the button before the Hardware Setting screen is displayed, the Measuring screen will be displayed.

The Hardware Setting screen is displayed.

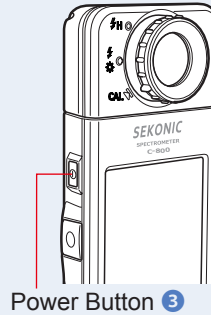
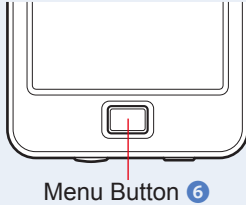

2. Touch the desired menu item.

The setting screen of the selected item will be displayed.

Refer to the explanations on the following page for each item setting.

3. When finished, touch the [Close] button.

This will return the display to the Measuring screen.

8-1 Adjust Touch Panel

Adjust the position of touch panel display.

Adjust Touch Panel Screen

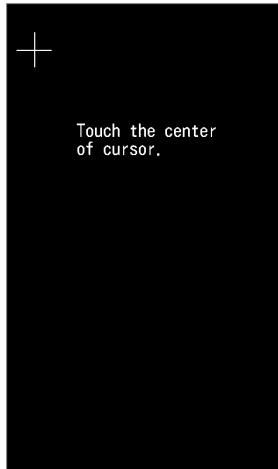

Operation

1. Touch the [Adjust Touch Panel] button on the Hardware Setting screen.

"Touch the center of cursor." will be displayed.

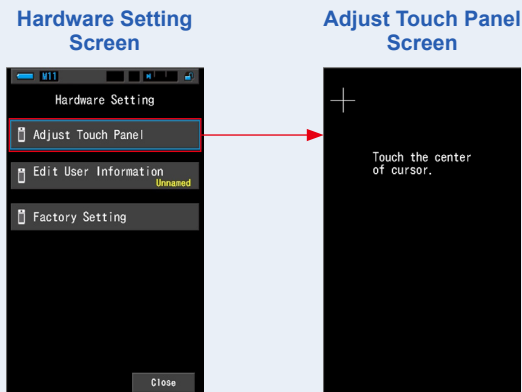

2. Touch the center of the white cross in the upper left corner of the screen.

The touched position will be shown with a red cross cursor, and the white cross cursor will move to the next position.

Adjust Touch Panel Screen

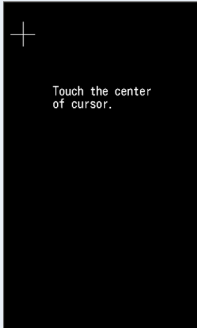

The touch position is showed with a red cross cursor

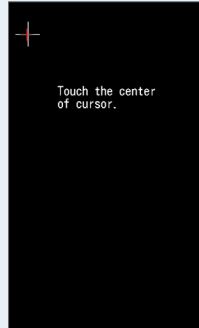

The white cross move to the next position

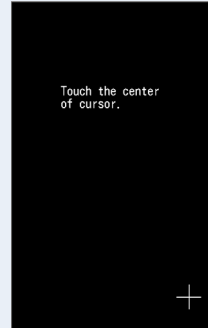

3. Repeat in 7 places.

Continue and repeat in 7 places.

The screen of "Press the "OK" to determine the touch panel adjustment." will be displayed.

Adjust Touch Panel Confirmation Screen

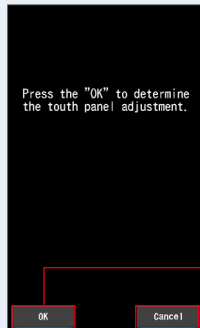

[OK] Button

[Cancel] Button

4. Touch the [OK] button.

Adjustment of touch panel is completed, and returns to the Hardware Setting screen.

To return to the Hardware Setting screen without adjusting the setting, touch the [Cancel] button.

Touch panel adjustment is completed.

 **NOTE**

When a point far from the white cursor is touched, the screen will blink to indicate adjustment failure.
Perform the adjustment again.

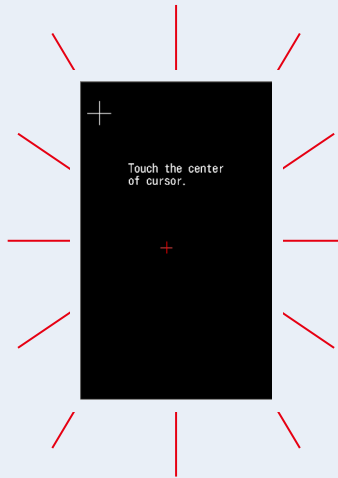
Adjust Touch Panel Screen

8-2 Edit User Information

User information can be input on this screen.

User Information Screen



NOTE

Up to 16 alphanumeric characters can be input.

Operation

1. Touch the [Edit User Information] button on the Hardware Setting screen.

The Edit User Information Input screen is displayed.

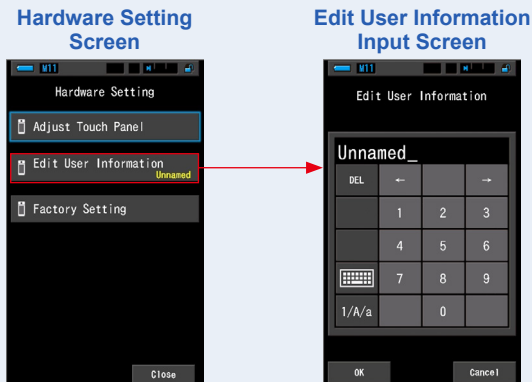

2. Edit the user information. (→ P18)

Edit User Information Input Screen



[OK] Button [Cancel] Button

3. Touch the [OK] button.

Registers the user information, and returns to the Hardware Setting screen.

To return to the Hardware Setting screen without registering the user information, touch the [Cancel] button.

Hardware Setting Screen

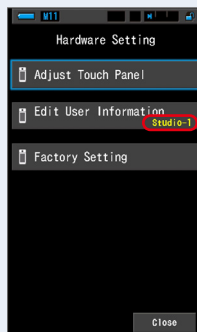

The set content is displayed.

The user information is input.

8-3 Factory Setting

Return all display and setting contents of the meter to the factory default.

Factory Setting Screen



Operation

1. Touch the [Factory Setting] button on the Hardware Setting screen.

The Factory Setting screen of "Reset to factory default settings. Are you sure?" will be displayed.

Hardware Setting Screen

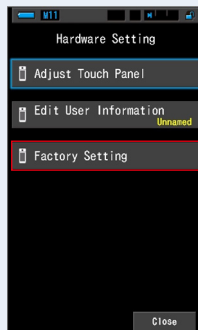

Factory Setting Screen



2. Touch the [Yes] button.

The factory setting confirmation message "All measurements will be lost when you perform this operation. Are you sure?" will be displayed.

Confirm again.

To return to the Hardware Setting screen without resetting to factory default settings, touch the [No] button.

Factory Setting Confirmation Screen

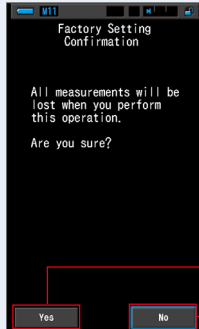

[Yes] Button

[No] Button

3. Touch the [Yes] button.



When the message "Deleting Memory. Please wait." or the progress bar is displayed, do not turn the power off.

All measurement values are deleted, and returns to the Hardware Setting screen. (English display is the default factory setting.)

Factory Setting Screen



Hardware Setting Screen

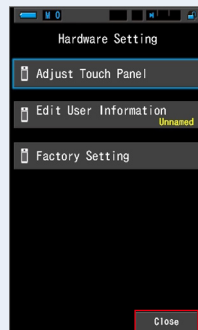

[Close] Button

4. Touch the [Close] button.

The Language Selection screen is displayed. Select the language to use. (→ P6)

Language Selection Screen



Language Selection Confirmation Screen

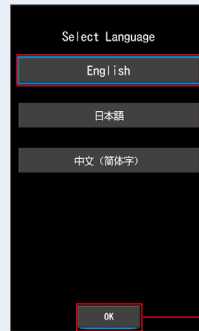

The selected button will be displayed encircled in blue.

[OK] Button

5. Touch the [OK] button.

The Measuring Screen will appear.

Measuring Screen

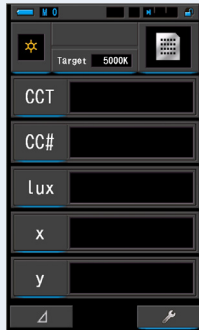

Factory setting is completed.

9. Appendix

9-1

Glossary

Term	Description
Color Temperature	<p>Color temperature refers to the chromaticity of a heated object (commonly refer to as a black body) that will vary according to its temperature. The color temperature is measured in units of Kelvin (K) and refers to the temperature of a heated object at a given color or chromaticity.</p> <p>The higher color temperature is, the bluer the light, and the larger the Kelvin value becomes. The lower the color temperature is, the redder the light, and the smaller the Kelvin value becomes.</p> <p>A figure that plots the changes of color temperatures on an xy chromaticity diagram is called the black body radiation locus.</p>
Correlated Color Temperature	<p>Not all light sources match the black body radiation locus when measuring light sources.</p> <p>In this case, the correlated color temperature is used. The correlated color temperature is a color temperature obtained by drawing an isothermperature line from the black body radiation locus which matches the measured value.</p>
Photographic Color Temperature	<p>Color temperature calculated by using the ratio of R, G and B characteristics obtained by measurement to match to the characteristic of film.</p>
Light (Visible light)	<p>This refers to the electromagnetic wavelength ranging from 380nm to 780nm that can be detected by the human eye.</p>
Black Body	<p>Theoretically, this is an object that absorbs all wavelengths and when heated, emits light equivalent to the applied color temperature.</p>
Black-body Radiation	<p>This refers to the light emitted by a black body.</p> <p>The amount of energy released for each wavelength changes with the applied color temperature, resulting in visible color variations.</p>
K	<p>Expressed in absolute Kelvin temperature, with units of "K". 0 (zero) K is equivalent to -273.15 °C or -459.67 °F.</p>
Δuv	<p>The deviation between the correlated color temperature and the black body radiation locus.</p> <p>When the correlated color temperature is above the black body radiation locus, a "+" sign is assigned; when below, a "-" sign is assigned.</p>

Term	Description
MK⁻¹	<p>Read as "per mega Kelvin", this unit is based on the International System of Units and is equivalent to the traditional unit of MIRED (mrd). It expresses the inverse of the color temperature. The inverse of the color temperature is 1,000,000 divided by the color temperature.</p> <p>Inverse color temperature = 1,000,000/Color temperature</p> <p>The inverse color temperature decreases as the color temperature increases. Ex.) 10,000K=100MK⁻¹, 3200K=312.5MK⁻¹</p> <p>If a 100K change is applied to both 10,000K and to 3,200K, the human eye perceives the change applied to 3,200K as larger. In other words, there is a difference in perception of the same change in color temperature depending on the color temperature's numerical value.</p> <p>When the inverse color temperature is used, the human eye perceives a given amount of change as the same for any color temperature.</p>
daMK⁻¹	<p>MK⁻¹ divided by 10. Because the unit MK⁻¹ is extremely small compared to the amount of change in color temperature the human eye can perceive, and because performing corrections is difficult, for practical purposes the unit daMK⁻¹ (deca per Mega Kelvin) is used. This unit is also used in conventional filters that change color temperature.</p>
LB Index	<p>The difference of the reciprocal of the selected color temperature and the reciprocal of the measured color temperature. It is expressed in units of MK⁻¹ (equivalent to MIRED) or daMK⁻¹.</p>
LB Filter	<p>Stands for "Light Balancing Filter", and refers to a filter used for correcting color temperature in photography. A blue filter is used to raise the light source color temperature, while an amber filter is used to lower it.</p> <p>By using the custom settings in the C-800, the display can be changed to show the type of the filter brand being used.</p>
CC Index	<p>Number that expresses the amount of difference between the G component (Green range) of the measured light source and the base black body radiation of the color temperature. 1CC index is equivalent to 2.5CC filter number.</p>
CC# (CC Filter Number)	<p>Number that expresses the amount of difference between the G component (Green range) of the measured light source and the base black body radiation of the color temperature. 1 CC# is equivalent to 0.4 CC index. In the past when film was popular, CC filter number is related to the actual CC filter. However, the sensor of C-800 which represents human eyes sensitivity sees the light in a different way from film, CC# is not related to CC filter directly.</p>
CC Filter	<p>Stands for "Color Compensating Filter", and refers to a filter used for correcting color in lighting.</p> <p>There are 6 different types of filters Yellow (Y), Magenta (M), Cyan (C), Blue (B), Green (G), and Red (R), but the C-800 uses the Magenta (M) and Green (G) types.</p>

Term	Description
CRI	<p>The Colour Rendering Index (CRI), defined by CIE (International Commission on Illumination) Publication 13.3, is widely used for assessing the colour rendering characteristics (the color appearance of objects) of light sources. The CRI values are based on the color appearance of objects compared to their appearance under the defined reference illuminant.</p> <p>In the CRI, there are special color rendering indices (R1 to R14, and R15) and the general color rendering index (Ra) which is the averaged value from R1 to R8.</p> <p>It was first published in 1965 after fluorescent lamps had emerged, and was last improved in 1974.</p>
TM-30	<p>Technical Memorandum TM-30 is, published by Illuminating Engineering Society (IES), the method for evaluating light source color rendition including LED lights.</p> <p>The C-800 with latest firmware shows TM-30-18 which Rf is identical with Rf of CIE 224:2017.</p> <p>The values are based on color appearance of objects with 99 color samples compared to their appearance under the defined reference illuminant.</p> <p>In the TM-30, there are Fidelity Index (Rf) which is to express how the accurate rendition of color is, and Gamut Index (Rg) to express what the average level of saturation is.</p>
SSI	<p>Spectral Similarity Index (SSI) is, defined by Academy of Motion Picture Arts and Sciences, Science and Technical Council, the method to express how close a test spectrum is to a reference spectrum. It is the index (SSI) to evaluate the similarity of spectrum of two light sources.</p>
TLCI-2012	<p>Television Lighting Consistency Index (TLCI), developed by EBU (European Broadcasting Union), the method to evaluate the color rendition (the color appearance of objects) under the reference light source with 24 color samples and a mathematical model of a broadcast camera to 'see' the colors.</p> <p>TLCI is suitable index to the evaluation of television lighting equipment.</p>
TLMF-2013	<p>Television Luminaire Matching Factor (TLMF) is, developed by EBU (European Broadcasting Union), a new companion metric to TLCI, TLMF allows you to compare two different lights to each other, rather than to a perfect reference, and see if they will play well together.</p> <p>TLMF is suitable index to the evaluation of television lighting equipment.</p>
Hue	<p>Hue is the word to express the color such as red, yellow, green, pale blue, blue, etc. The unit of hue is a degree.</p>
Sat (Saturation)	<p>Saturation is the index to express the intensity or chroma. The unit is from 0 to 100%, which means 0% is no saturation and 100% is maximum saturation.</p>
HSI Color Space	<p>HSI is the abbreviation of Hue, Saturation and Intensity which the color space is composed of.</p> <p>Because the C-800 measures the light source, it shows the hue and saturation at 50% of intensity.</p>

Term	Description
HSV Color Space	HSV is the abbreviation of Hue, Saturation and Value which the color space is composed of. Because the C-800 measures the light source, it shows the hue and saturation at 100% of value.
White Point	It is the coordinates of "white color" which is the standard of color space on the chromaticity diagram.



NOTE

LBi (LB index) is the correction value between target color temperature and actual measured color temperature. CCI (CC index) and CC# (CC filter number) are the values to correct a difference from black body radiation. In the past years when film mode is available (such as C-700, C-500 and other traditional photographic color meters), LBi, CCI or CC# can be correlated with actual lighting filter or camera filter number (LBIf: LB lighting filter, LBcf: LB camera filter, CCIf: CC lighting filter or CCcf: CC camera filter). However, in digital mode or industrial spectrometer, LBi, CCI or CC# has no more correlation with actual lighting filter or camera filter number (LBIf, LBcf, CCIf or CCcf). This is because these filters were designed in film age, and spectral sensitivity of filters were designed to match to film sensitivities which Blue, Green and Red sensitivity is clearly separate. So, LB index or CC index (CC filter number) can be simply calculated in formula. However, digital mode which represents human eyes characteristic has close sensitivities between Green and Red sensor. This makes both LB filter and CC filter to be used at the same time to achieve the target color temperature, and LB/CC index or CC# has no direct correlation with lighting or camera filter numbers.

Film Sensitivity

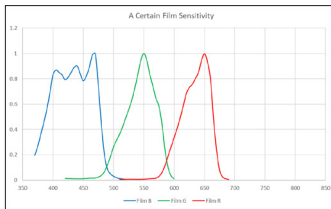

Human Eyes Sensitivity

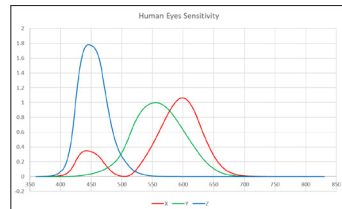

9-2 Filter Types

When using camera LB/CC filters based on the recommended compensation displayed in the meter (C-800), please note that camera lens filters block or absorb light to produce their effect and thus the amount of light passing through them for exposure will be reduced.

If your camera does not have a through the lens exposure system and you are using a handheld exposure meter to determine camera settings, consult the table below to find how much to increase the exposure to compensate for the light absorbed by the lens filter.

When you use a lighting filter, exposure compensation is not necessary, because the intensity of the light is already decreased.

■ Kodak WRATTEN 2/LEE Filter [Camera Filter]

Amber Type		Blue Type	
Filter Number	Exposure Increase Increment (+EV)	Filter Number	Exposure Increase Increment (+EV)
81	1/3	82	1/3
81A	1/3	82A	1/3
81B	1/3	82B	2/3
81C	1/3	82C	2/3
81D	2/3	80D	2/3
81EF	2/3	80C	1
85C	1/3	80B	1 2/3
85	2/3	80A	2
85B	2/3		

Magenta Type		Green Type	
Filter Number	Exposure Increase Increment (+EV)	Filter Number	Exposure Increase Increment (+EV)
CC025M	0	CC025G	0
CC05M	1/3	CC05G	1/3
CC10M	1/3	CC10G	1/3
CC20M	1/3	CC20G	1/3
CC30M	2/3	CC30G	2/3
CC40M	2/3	CC40G	2/3
CC50M	1	CC50G	2/3

■ FUJIFILM Filter [Camera Filter]

Amber Type		Blue Type	
Filter Number	Exposure Increase Increment (+EV)	Filter Number	Exposure Increase Increment (+EV)
LBA-1	0	LBB-1	0
LBA-2	$\frac{1}{3}$	LBB-2	$\frac{1}{3}$
LBA-3	$\frac{1}{3}$	LBB-3	$\frac{1}{2}$
LBA-4	$\frac{1}{3}$	LBB-4	$\frac{2}{3}$
LBA-6	$\frac{2}{3}$	LBB-6	$\frac{2}{3}$
LBA-8	$\frac{2}{3}$	LBB-8	1
LBA-12	$\frac{2}{3}$	LBB-12	$1\frac{2}{3}$
LBA-16	1	LBB-16	2
LBA-20	1	LBB-20	$2\frac{1}{3}$

Magenta Type		Green Type	
Filter Number	Exposure Increase Increment (+EV)	Filter Number	Exposure Increase Increment (+EV)
CC-1.25M	0	CC-1.25G	0
CC-2.5M	0	CC-2.5G	0
CC-5M	$\frac{1}{3}$	CC-5G	$\frac{1}{4}$
CC-7.5M	$\frac{1}{3}$	CC-7.5G	$\frac{1}{3}$
CC-10M	$\frac{1}{2}$	CC-10G	$\frac{1}{3}$
CC-20M	$\frac{2}{3}$	CC-20G	$\frac{1}{2}$
CC-30M	$\frac{2}{3}$	CC-30G	$\frac{2}{3}$
CC-40M	1	CC-40G	$\frac{2}{3}$
CC-50M	$1\frac{1}{3}$	CC-50G	1

■ LEE [Lighting Filter]

Filter No.	Filter Name	CCT(K) Conversion
L218	1/8 CTB	3200 to 3400
L203	1/4 CTB	3200 to 3600
L202	1/2 CTB	3200 to 4300
L281	3/4 CTB	3200 to 5000
L201	FULL CTB	3200 to 5700
L283	ONE AND 1/2 CTB (1.5 CTB)	3200 to 8888
L200	DOUBLE CTB	3200 to 26000
L223	1/8 CTO	6500 to 5550
L206	1/4 CTO	6500 to 4600
L205	1/2 CTO	6500 to 3800
L285	3/4 CTO	6500 to 3600
L204	FULL CTO	6500 to 3200
L286	ONE AND 1/2 CTO (1.5 CTO)	6500 to 2507
L287	DOUBLE CTO	6500 to 2147

Filter No.	Filter Name	CC Filter Equivalent
L278	1/8 PLUS GREEN (1/8 PLUS G)	CC 035 Green
L246	1/4 PLUS GREEN (1/4 PLUS G)	CC 075 Green
L245	1/2 PLUS GREEN (1/2 PLUS G)	CC 15 Green
L244	FULL PLUS GREEN (PLUS GREEN)	CC 30 Green
L279	1/8 MINUS GREEN	CC 035 Magenta
L249	1/4 MINUS GREEN	CC 075 Magenta
L248	1/2 MINUS GREEN	CC 15 Magenta
L247	FULL MINUS GREEN	CC 30 Magenta

() Displayed in C-800

■ ROSCO CINEGEL [Lighting Filter]

Filter No.	Filter Name	CCT(K) Conversion
R3216	1/8 CTB	3200 to 3300
R3208	1/4 CTB	3200 to 3500
R3206	1/3 CTB	3200 to 3800
R3204	1/2 CTB	3200 to 4100
R3203	3/4 CTB	3200 to 4700
R3202	FULL CTB	3200 to 5500
R3220	DOUBLE CTB	2800 to 10000
R3410	1/8 CTO	5500 to 4900
R3409	1/4 CTO	5500 to 4500
R3408	1/2 CTO	5500 to 3800
R3411	3/4 CTO	5500 to 3200
R3407	FULL CTO	5500 to 2900
R3420	DOUBLE CTO	10000 to 2400

Filter No.	Filter Name	CC Filter Equivalent
R3317	1/8 PLUS GREEN (1/8 PLUS G)	CC 035 Green
R3316	1/4 PLUS GREEN (1/4 PLUS G)	CC 075 Green
R3315	1/2 PLUS GREEN (1/2 PLUS G)	CC 15 Green
R3304	PLUS GREEN	CC 30 Green
R3318	1/8 MINUS GREEN (1/8 MINUS G)	CC 035 Magenta
R3314	1/4 MINUS GREEN (1/4 MINUS G)	CC 075 Magenta
R3313	1/2 MINUS GREEN (1/2 MINUS G)	CC 15 Magenta
R3309	3/4 MINUS GREEN (3/4 MINUS G)	CC 22.5 Magenta
R3308	MINUS GREEN	CC 30 Magenta

() Displayed in C-800

■ ROSCO E-COLOUR+ [Lighting Filter]

Filter No.	Filter Name	CCT(K) Conversion
E218	1/8 CTB	3200 to 3400
E203	1/4 CTB	3200 to 3600
E202	1/2 CTB	3200 to 4300
E281	3/4 CTB	3200 to 5000
E201	FULL CTB	3200 to 5700
E283	ONE AND 1/2 CTB (1.5 CTB)	3200 to 8900
E200	DOUBLE CTB	2800 to 10000
E223	1/8 CTO	Daylight to 5300
E206	1/4 CTO	Daylight to 4600
E205	1/2 CTO	Daylight to 3800
E285	3/4 CTO	Daylight to 3500
E204	FULL CTO	Daylight to 3200
E286	ONE AND 1/2 CTO (1.5 CTO)	Daylight to 2507
E287	DOUBLE CTO	Daylight to 2120

Filter No.	Filter Name	CC Filter Equivalent
E278	1/8 PLUS GREEN	CC 035 Green
E246	1/4 PLUS GREEN	CC 075 Green
E245	1/2 PLUS GREEN	CC 15 Green
E244	FULL PLUS GREEN	CC 30 Green
E279	1/8 MINUS GREEN	CC 035 Magenta
E249	1/4 MINUS GREEN	CC 075 Magenta
E248	1/2 MINUS GREEN	CC 15 Magenta
E247	FULL MINUS GREEN	CC 30 Magenta

() Displayed in C-800

* Kodak and Wratten are trademarks of Eastman Kodak Company.

* Fujifilm is a registered trademark of Fujifilm Corporation.

* LEE is a registered trade mark of Lee Filters, a division of Panavision Europe Ltd.

* Rosco, Cinegel, and E-Colour+ are a registered trademarks of Rosco Laboratories Inc.

* All other company or product names are trademarks or registered trademarks of the respective companies.

9-3

Specifications

Type

- Spectrometer with CMOS linear image sensor for digital cameras

Illuminance meter class

- Conforms to JIS C 1609-1:2006 for General Class A Illuminance Meters

Light receiving method

- Incident light

Light receptor

- White diffuser (fixed type)

Measuring distance

- 0.5m to ∞ = 1.64ft to ∞

Light receptor element

- CMOS linear image sensor 128 pixels

Spectral wavelength range

- 380nm to 780nm

Spectral bandwidth

- Approximately 11nm (half bandwidth)

Measurement system

• Measuring mode	• Ambient light • Flash light	Ambient light mode Cord flash mode with sync cord Cordless flash mode
• Measurement type	• Color measurement • Illuminance	Color temperature measurement based on color matching function (Correlated color temperature) Complies with JIS C1609-1:2006 general A class illuminometer
• Display mode	• Color measurement	Text mode, Spectrum mode, Spectrum Comp. mode, CRI mode, CRI Comp. mode, TM-30 mode, SSI mode, TLCI/TLMF mode, Filter (Camera/Lighting) mode, Multi Lights mode, WB Corr. mode

Measurement range

• Illuminance in color temperature measurement	• Ambient light • Flash light	5lx to 200,000lx 0.46fc to 18,600fc 20lx·s to 20,500lx·s 1.86fc·s to 1,900fc·s
• Illuminance	• Ambient light	1lx to 200,000lx 0.09fc to 18,600fc
• Exposure	• Flash light	Range L: 20lx·s to 640lx·s (f/2.8 to f/16) 1.86fc·s to 59.5fc·s Range H: 580lx·s to 20,500lx·s (f/11.9 to f/90) 53.9fc·s to 1,900fc·s
• Correlated color temperature	• Ambient light • Flash light	1,600K to 40,000K 4,000K to 10,000K (20lx·s to 20,500lx·s = 1.86fc·s to 1,900fc·s 380nm to 780nm) 2,500K to 4,000K, 10,000K to 40,000K (20lx·s to 10,200lx·s = 1.86fc·s to 947fc·s 400nm to 700nm)
• Color rendering properties	• CRI • TM-30 • SSI • TLCI-2012 • TLMF-2013	Ra, R1 to R15 -100.0 to 100.0 Rf 0 to 100 Rg 0 to 200 SSI 0 to 100 Qa 0 to 100 ΔQa 0 to 100 (5lx to 200,000lx = 0.46fc to 18,600fc)
• Chromaticity coordinate x, y	• CIE1931	0.0000 to 1.0000 (5lx to 200,000lx = 0.46fc to 18,600fc)
• Hue	• HSV • HSI	0° to 359° 0° to 359° (5lx to 200,000lx = 0.46fc to 18,600fc)
• Saturation	• HSV • HSI	0% to 100% 0% to 100% (5lx to 200,000lx = 0.46fc to 18,600fc)

Accuracy

• Illuminance	±5% ±1digit of indicated value (Complies with JIS C1609-1:2006 general A class illuminometer)
• Color temperature	±4MK ⁻¹ (Light source A, 800lx = 74.3fc)

Repeatability (2σ)

• Illuminance	1% + 1digit (Light source A, 30lx ~ 200,000lx to 2.79fc to 18,600fc) 5% + 1digit (Light source A, 1lx ~ 30lx to 0.09fc to 2.79fc)
• Color temperature	2MK-1 (Light source A, 500lx ~ 200,000lx to 46.5fc to 18,600fc) 4MK-1 (Light source A, 100lx ~ 500lx to 9.29fc to 46.5fc) 8MK-1 (Light source A, 30lx ~ 100lx to 2.79fc to 9.29fc) 17MK-1 (Light source A, 5lx ~ 30lx to 0.46fc to 2.79fc)

Switching range L/H

• Tolerance of color temperature	$\pm 8\text{MK}^{-1}$
----------------------------------	-----------------------

Spectral response characteristics

• f_1'	9% or less (Complies with JIS C1609-1:2006 general A class illuminometer)
----------	---

Oblique incident light characteristics

• f_2	6% or less (Complies with JIS C1609-1:2006 general A class illuminometer)
---------	---

Temperature characteristics

• Illuminance	$\pm 5\%$ of indicated value (Complies with JIS C1609-1:2006 general A class illuminometer)
• Color temperature	$\pm 12\text{MK}^{-1}$ (Light source A, 1,000lx =92.9fc)

Humidity characteristics

• Illuminance	$\pm 3\%$ of indicated value (Complies with JIS C1609-1:2006 general A class illuminometer)
• Color temperature	$\pm 12\text{MK}^{-1}$ (Light source A, 1,000lx =92.9fc)

Display range

• Target color temperature settings	2,500K to 10,000K
• LB Index	<ul style="list-style-type: none"> • 1MK^{-1} step -500MK^{-1} to $+500\text{MK}^{-1}$ • 1daMK^{-1} step Without decimal point: -50daMK^{-1} to $+50\text{daMK}^{-1}$ • 0.1daMK^{-1} step With decimal point: -50.0daMK^{-1} to $+50.0\text{daMK}^{-1}$
• CC index	• 80G ~ 80M

• Illuminance	• Ambient light	1lx to 200,000lx (3 significant digits) 0.09fc to 18,600fc (3 significant digits)
• Exposure	• Flash light	Range L: 20lx·s to 640lx·s 1.86fc·s to 59.5fc·s Range H: 580lx·s to 20,500lx·s 53.9fc·s to 1,900fc·s
• Shutter speed	• Flash light	1 second to 1/500 second (in 1, 1/2, 1/3 step) plus: 1/75, 1/80, 1/90, 1/100, 1/200, 1/400 second
• Color rendering properties	• CRI • TM-30 • SSI • TLCI-2012 • TLMF-2013	Ra, R1 to R15 -100.0 to 100.0 Rf 0 to 100 Rg 0 to 200 SSI 0 to 100 Qa 0 to 100 ∠ Qa 0 to 100 (5lx to 200,000lx = 0.46fc to 18,600fc)
• Chromaticity coordinate x, y	• CIE1931	0.0000 to 1.0000 (5lx to 200,000lx = 0.46fc to 18,600fc)
• Hue	• HSV • HSI	0° to 359° 0° to 359° (5lx to 200,000lx = 0.46fc to 18,600fc)
• Saturation	• HSV • HSI	0% to 100% 0% to 100% (5lx to 200,000lx = 0.46fc to 18,600fc)

Other functions

- Preset setting
 - Preset 1 ~ 19 settings for each digital or film mode
- Custom Setting
 - 12 items
- Memory function
 - Up to 99 measurements or titles
- Memory clear/recall /rename function
- Out of measurement range or out of display range
 - [Under]/[Over]/[Filter N/A] warning display
- Battery capacity indicator display
 - With 4 level status icons
- Automatic power OFF function
 - Selectable from 20min., 10min., 5min. from last use or no auto power off.

- LCD backlight
 - Brightness can be selectable from bright, normal, or dark.
 - Dimmer can be selectable from 20, 40, 60 sec. from last use or no dimmer.
- Touch panel lock function
 - Hold MENU button down for 3 seconds to lock and unlock.
- Tripod socket
 - 1/4-inch, 20 threads

Display

- LCD display resolution
 - 4.3 inch QVGA 480×800 dots

Recommended battery

- AA batteries
 - 1.5V × 2 alkaline, manganese
- USB bus-power
 - 5V/500mA or less (via USB cable when connected to computer)

Operating temperature

- -10°C ~ 40°C (without condensation)

Operating humidity

- 85%RH or less (at 35°C) (without condensation)

Transportation and storage conditions

- -10°C ~ 60°C (without condensation)

Dimensions

- Approx. 73 (width) × 183 (height) × 27 (depth) mm
(excluding protruding part of light receiving) (max. thickness 40mm)

Weight

- approx. 230g (without batteries)

Included accessories

- Soft case, Strap, Start-up Guide, Safety Precaution

* Models sold in some countries do not display illuminance and exposure in "fc (fc·s)" due to legal restrictions. In this case, Unit of Illuminance is not displayed.





* Specifications and appearance described in this Operating Manual are subject to change without prior notice for improvements.

9-4

Legal Requirement

■ Legal Requirement

This product complies with the following legal requirements.

Destination	Standard		Details
Europe	CE 	SAFETY	EN 62368-1
		EMC	EMS: EN 55024 EMI : EN 55032
		Environmental	WEEE
			RoHS
REACH			
North America	FCC (US) 	EMC	FCC Part15 SubpartB ClassB
	IC (Canada)	EMC	ICES-003
Japan	Environmental		Containers and Packaging Recycling Law
China	Environmental		China RoHS (GB 189455)
South Korea	KC	EMC	KN 11 KN 61000-6-1
			1. 기자재의명칭 (모델명) :COLOR METER (C-800) 2. 식별부호 : MSIP-REM-SK0-C-700 3. 상호명 : SEKONIC CORPORATION 4. 제조자 : SEKONIC CORPORATION 5. 제조국가 : 일본
UK (Great Britain)	UKCA 	SAFETY	Electrical Equipment (Safety) Regulations 2016
		EMC	Electromagnetic Compatibility Regulations 2016
		Environmental	RoHS Regulations 2012

10. Optional Accessories

■ Synchro Cord

This is a five-meter (16.4 feet) long cord with three plugs.

An exposure meter, a camera and a flash can all be connected at the same time without having to plug or unplug the cord during shooting. Also, the connection terminal (male) on the light meter side of the synchro cord has a locking mechanism to ensure it remains connected to the meter.

(1 male terminal on the light meter side, 1 male terminal and 1 female terminal)

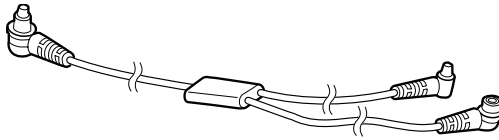

11. Troubleshooting

The following cases may not suggest failures. Please check again before requesting repair. When the meter does not function normally after checking the following, it may be damaged. Remove the battery, and ask the retailer or us to repair it.

Status	Check item	Measure
It does not turn on (It does not display)	Are you pressing and holding the Power Button for one or more seconds?	Press and hold the Power Button for one or more seconds.
	Are ⊕ ⊖ of the batteries inserted properly?	Check the ⊕ ⊖ signs. (➔ P4)
	Is there enough battery?	Replace the battery. (➔ P10)
	Are the battery terminals dirty?	Wipe them off with a dry cloth.
	Are you using the specified batteries?	Check the batteries. (➔ P4)
The LCD does not respond	Is the screen locked?	Press and hold the Menu Button 6 to unlock the screen. (➔ P19)
Sometimes, measurement cannot be made with USB bus power	Is C-800 Utility communicating with the meter?	If the USB icon appears on the C-800 LCD, the meter is communicating with Utility. Please wait until the communication is finished. Also, if you open the [Memory Data] screen in the Utility, it is always communicating with the meter. Please close [Memory Data] screen to use the meter with bus power.
The measured values are wrong	Is the Light Selection Ring 2 in the middle position? The light distribution characteristics change and suitable measurements cannot be made.	Rotate the Light Selection Ring 2 until it clicks.
	Are any unnecessary corrections or filter corrections set?	Check the Target (color temperature) to see if the setting is wrong. (➔ P26)
		Check the Preset Target Color Temperature and confirm the setting is correct. (➔ P163)

Status	Check item	Measure
The measured values are wrong	Is the measuring mode wrong? (Such as measuring in Ambient Light Mode in flash light)	Check if the measuring mode is correct. (➔ P22)
	Are you using the pre-flash function when measuring in Cordless Flash Mode?	In Cordless Flash Mode, the measurement value of the main flash may not be displayed because the pre-flash is measured at first. Cancel the pre-flash function.
Setting values and measurement values of the spectrometer are not in the camera settings	Do the shutter speed and iris setting step of the camera and the shutter speed and iris setting step of the spectrometer match?	Some cameras can select 1/3 step, 1 step and 1/2 step, like a spectrometer. Match the step of the spectrometer with the step of the camera. (Shutter Speed Step) (➔ P129)
The memory function cannot be used	Is the comparison mode activated?	The memory function cannot be used when the comparison mode is used. Deactivate the comparison mode.
	Is "Memory Full" displayed when pressing the Memory Button?	The memory can store up to 99 values. Clear unnecessary memory values in advance, measure, and memorize it.
The spectrum graph does not appear in the measuring of blue LED.	Is the measured light source bright enough?	If the measured light source is not bright enough, increase the output of the light source and measure it. There is a possibility that LED with narrow spectral half bandwidth cannot give enough light amount to measure properly.
There is a rattling in the light receptor.	Is the light selection ring smoothly rotating? Does the light receptor go up and down smoothly?	Small rattling is not malfunction and necessary as the mechanism for switching. However, when the rattling is too much, or there is any abnormality in rotating the light selection ring, there is a possibility of faulty in the products. Contact with local retailer or Sekonic.

Status	Check item	Measure
There is some difference in reading between range L and range H when switching.	Is the light selection ring smoothly rotating? Does the light receptor go up and down smoothly?	When the location of light selection ring is not correct, the measurement may be wrong. Check if it is located properly. The tolerance range of measurement for product assurance between range L and H is $\pm 8 \text{ MK-1}$.
The sensitivity of touch screen is not good.	Is there any difference between the touch panel sensor position and actual touched position?	According to this operating manual "8-1. Adjust Touch Panel" (→ P178), proceed the adjustment of touch panel position. To prevent misoperation, the resistance film type touch panel is used instead of electrostatic capacitance system touch panel used in the general smart phone. Press the touch panel with your nail if the sensitivity is not enough.
In some cases, the measuring time is longer.	Are you measuring the ambient light with range H by mistake?	For ambient light measurement, please use the range L. If you use the range H, the less light through ND filter is coming into the sensor and it takes longer time to measure. This product uses the spectral distribution type sensor, so depending on the illuminance of light, the measuring time to display the reading will vary from 1sec. to 15sec.

12. After-sales Services

- Contact your local distributor or camera store that you purchased from for warranty and service.
- Even within the warranty period, repair services may be provided on a paid basis. Check the conditions of warranty provided by local distributor or retailer.
- The warranty is not valid unless the copy of proof of purchase with the date of purchase and the retailer name. Be sure to store such information (bill of purchase or receipt) in a safe location.
- We will retain performance parts for repairs for approximately seven years after production is discontinued. Therefore, we may not be able to carry out repairs after this period has elapsed.
- When requesting repairs, please provide us with as much detail as possible about the failure or specific failure locations that you are able to identify. In certain cases, some products that are returned to us for repairs are not malfunctioning, and begin to operate normally again when we simply replace the batteries. Before requesting repairs, please confirm that the batteries are installed in the correct polarities, contain sufficient charge, and that they match the rating.
- Repair service will be refused if there is a breakdown or damage due to disassembly or modification (including software), or if there are traces of disassembly or modification, even for products for which repairs are accepted.

FCC & IC compliance information

This equipment has been tested and found to comply with the limits for a Class B digital device, pursuant to Part 15 of the FCC Rules. These limits are designed to provide reasonable protection against harmful interference in a residential installation. This equipment generates, uses and can radiate radio frequency energy and, if not installed and used in accordance with the instruction, may cause harmful interference to radio communications.

However, there is no guarantee that interference will not occur in a particular installation. If this equipment does cause harmful interference to radio or television reception, which can be determine by turning the equipment off and on, the user is encouraged to try to correct the interference by one or more of the following measures:

- Reorient or relocate the receiving antenna.
- Increase the separation between the equipment and receiver.
- Connect the equipment into an outlet on a circuit different from that to which the receiver is connected.
- Consult the dealer or an experienced radio/TV technician for help.

Caution: Any changes or modifications to this device not explicitly approved by manufacturer could void your authority to operate this equipment.

FCC Warning

This device complies with part 15 of the FCC Rules. Operation is subject to the following two conditions: (1) This device may not cause harmful interference, and (2) this device must accept any interference received, including interference that may cause undesired operation.

For Canada CAN ICES-003(B) / NMB-003 (B)

IC Warning

This device complies with Industry Canada licence-exempt RSS standard(s).

Operation is subject to the following two conditions: (1) this device may not cause interference, and (2) this device must accept any interference, including interference that may cause undesired operation of the device.

Le présent appareil est conforme aux CNR d'Industrie Canada applicables aux appareils radio exempts de licence. L'exploitation est autorisée aux deux conditions suivantes : (1) l'appareil ne doit pas produire de brouillage, et (2) l'utilisateur de l'appareil doit accepter tout brouillage radioélectrique subi, même si le brouillage est susceptible d'encompromettre le fonctionnement.

SEKONIC CORPORATION

7-24-14, Oizumi-Gakuen-Cho, Nerima-Ku, Tokyo
178-8686 Japan

Tel +81-3-3978-2335 Fax +81-3-3978-5229

<https://www.sekonic.com>

JT8197563
November 2022